

INTEZAR CNC

ENTERPRISES

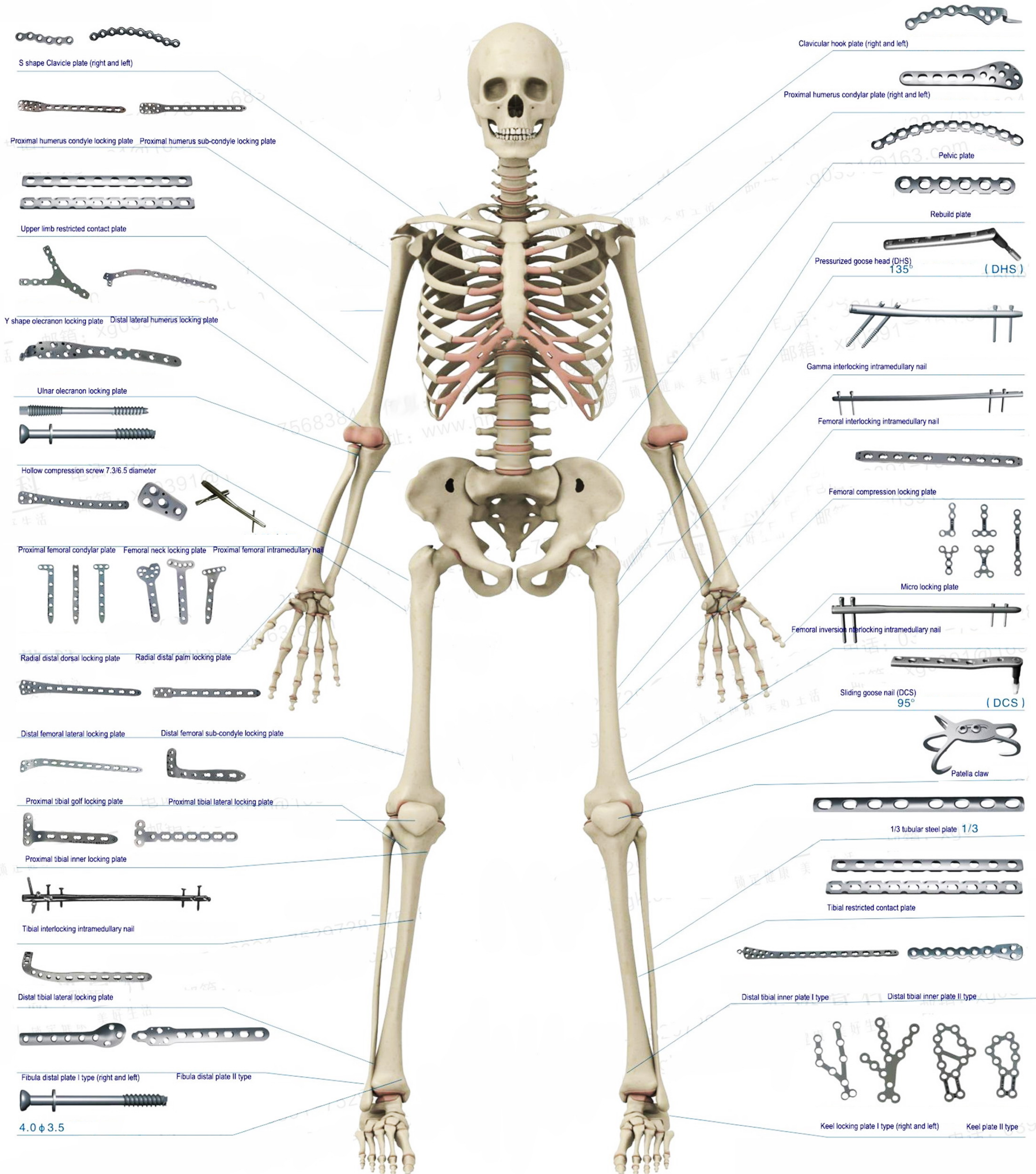

Address :
 Khan Mahal Road,
 Sialkot-51310 PAKISTAN
 Ph: +92 322 735 0580
 E-mail: info@intezarcnc.com
 Web: www.intezarcnc.com

SMALL BONE PLATE

4110 | Ulnar Radialis Plate

4110-3/5004~4110-3/5012



Product No.		Holes	Plate Length×Width×Thickness
Pure Titanium	Stainless Steel		
4110-3004	4110-5004	4	51×10×3
4110-3005	4110-5005	5	64×10×3
4110-3006	4110-5006	6	77×10×3
4110-3007	4110-5007	7	90×10×3
4110-3008	4110-5008	8	103×10×3
4110-3009	4110-5009	9	116×10×3
4110-3010	4110-5010	10	129×10×3
4110-3011	4110-5011	11	142×10×3
4110-3012	4110-5012	12	155×10×3

Note: Select HA3.5 cortex screws

4123 |

LC-DCP For Ulnar Radialis Plate

4123-3/5004~4123-3/5014



Product No.		Holes	Plate Length×Width×Thickness
Pure Titanium	Stainless Steel		
4123-3004	4123-5004	4	51×10×3
4123-3005	4123-5005	5	64×10×3
4123-3006	4123-5006	6	77×10×3
4123-3007	4123-5007	7	90×10×3
4123-3008	4123-5008	8	103×10×3
4123-3009	4123-5009	9	116×10×3
4123-3010	4123-5010	10	129×10×3
4123-3011	4123-5011	11	142×10×3
4123-3012	4123-5012	12	155×10×3
4123-3013	4123-5013	13	168×10×3
4123-3014	4123-5014	14	181×10×3

Note: used for upper limb with HA3.5 cortex screws

4111 |

DCP For Upper Limb

4111-3/5004~4111-3/5012



Product No.		Holes	Plate Length×Width×Thickness
Pure Titanium	Stainless Steel		
4111-3004	4111-5004	4	52×12×3
4111-3005	4111-5005	5	64×12×3
4111-3006	4111-5006	6	76×12×3
4111-3007	4111-5007	7	88×12×3
4111-3008	4111-5008	8	100×12×3
4111-3009	4111-5009	9	112×12×3
4111-3010	4111-5010	10	124×12×3
4111-3011	4111-5011	11	136×12×3
4111-3012	4111-5012	12	148×12×3

Note: used for upper limb with HA3.5 cortex screws

4112 |

LC-DCP For Upper Limb

4112-3/5004~4112-3/5012



Product No.		Holes	Plate Length×Width×Thickness
Pure Titanium	Stainless Steel		
4112-3004	4112-5004	4	70×12×4
4112-3005	4112-5005	5	84×12×4
4112-3006	4112-5006	6	98×12×4
4112-3007	4112-5007	7	112×12×4
4112-3008	4112-5008	8	126×12×4
4112-3009	4112-5009	9	140×12×4
4112-3010	4112-5010	10	154×12×4
4112-3011	4112-5011	11	168×12×4
4112-3012	4112-5012	12	182×12×4

Note: used for upper limb with HA3.5 cortex screws

SMALL BONE PLATE

4117 | Common Plate

4117-3/5103~4117-3/5718



Product No.		Holes	Plate Length×Width×Thickness
Pure Titanium	Stainless Steel		
4117-3103	4117-5103	3	45×10×2.5
4117-3204	4117-5204	4	60×10×2.5
4117-3304	4117-5304	4	75×10×2.5
4117-3406	4117-5406	6	90×10×2.5
4117-3506	4117-5506	6	105×10×2.5
4117-3616	4117-5616	6	125×10×3.0
4117-3718	4117-5718	8	140×10×3.0

Note: used for upper limb with HA3.5 and HA4 cortex screws

4118 | One-third Tubular Plate

4118-3/5003~4118-3/5012



Product No.		Holes	Length
Pure Titanium	Stainless Steel		
4118-3003	4118-5003	3	37
4118-3004	4118-5004	4	49
4118-3005	4118-5005	5	61
4118-3006	4118-5006	6	73
4118-3007	4118-5007	7	85
4118-3008	4118-5008	8	97
4118-3009	4118-5009	9	109
4118-3010	4118-5010	10	121
4118-3011	4118-5011	11	133
4118-3012	4118-5012	12	145

Note: used for radius and fibula with HA3.5 cortex screws

4119 | Reconstruction Plate

4119-3/5004~4119-3/5016



Product No.		Holes	Length
Pure Titanium	Stainless Steel		
4119-3004	4119-5004	4	46
4119-3005	4119-5005	5	58
4119-3006	4119-5006	6	70
4119-3007	4119-5007	7	82
4119-3008	4119-5008	8	94
4119-3009	4119-5009	9	106
4119-3010	4119-5010	10	118
4119-3011	4119-5011	11	130
4119-3012	4119-5012	12	142
4119-3014	4119-5014	13	154
4119-3016	4119-5016	14	166

Note: select HA3.5 and HA4 cortex screws

4120 | Clavicular Plate

4120-3/5004~4120-3/5012



Product No.		Holes	Length
Pure Titanium	Stainless Steel		
4120-3004	4120-5004	4	46
4120-3005	4120-5005	5	58
4120-3006	4120-5006	6	70
4120-3007	4120-5007	7	82
4120-3008	4120-5008	8	94
4120-3009	4120-5009	9	106
4120-3010	4120-5010	10	118
4120-3011	4120-5011	11	130
4120-3012	4120-5012	12	142

Note: select HA3.5 and HB3.5 screws

SMALL BONE PLATE

4312 | Proximal Humeral Plate

4312-3/5004~4312-3/5010



Product No.		Holes	Length
Pure Titanium	Stainless Steel		
4312-3004	4312-5004	4	79
4312-3005	4312-5005	5	94
4312-3006	4312-5006	6	109
4312-3007	4312-5007	7	124
4312-3008	4312-5008	8	139
4312-3009	4312-5009	9	154
4312-3010	4312-5010	10	169
HA3.5,HB4 Note:Select HA3.5 and HB4 screws			

4313 | Proximal Humeral Plate

4313-3/5004~4313-3/5110



Product No.		Holes	Length
Pure Titanium	Stainless Steel		
4313-3004	4313-5004	4 L	87
4313-3104	4313-5104	4 R	87
4313-3005	4313-5005	5 L	99
4313-3105	4313-5105	5 R	99
4313-3006	4313-5006	6 L	111
4313-3106	4313-5106	6 R	111
4313-3007	4313-5007	7 L	123
4313-3107	4313-5107	7 R	123
4313-3008	4313-5008	8 L	135
4313-3108	4313-5108	8 R	135
4313-3009	4313-5009	9 L	147
4313-3109	4313-5109	9 R	147
4313-3010	4313-5010	10 L	159
4313-3110	4313-5110	10 R	159
HA3.5,HB4 Note:Select HA3.5 and HB4 screws			

Distal Humeral Plate

4314-3/5003~4314-3/5107



Product No.		Holes	Length
Pure Titanium	Stainless Steel		
4314-3003	4314-5003	3 L	88
4314-3103	4314-5103	3 R	88
4314-3004	4314-5004	4 L	103
4314-3104	4314-5104	4 R	103
4314-3005	4314-5005	5 L	118
4314-3105	4314-5105	5 R	118
4314-3006	4314-5006	6 L	133
4314-3106	4314-5106	6 R	133
4314-3007	4314-5007	7 L	148
4314-3107	4314-5107	7 R	148
HA3.5,HB4 Note:Select HA3.5 and HB4 screws			

4320 |

Distal Medial Humeral Plate

4320-3/5008~4320-3/5016



Product No.		Holes	Length
Pure Titanium	Stainless Steel		
4320-3008	4320-5008	8	72
4320-3009	4320-5009	9	82
4320-3010	4320-5010	10	92
4320-3011	4320-5011	11	102
4320-3012	4320-5012	12	112
4320-3013	4320-5013	13	122
4320-3014	4320-5014	14	132
4320-3015	4320-5015	15	142
4320-3016	4320-5016	16	152
HA3.5,HB4 Note:Select HA3.5 and HB4 screws			

SMALL BONE PLATE

4319 |

Distal Lateral Humeral Plate

4319-3/5010~4319-3/5120



Product No.		Holes	Length
Pure Titanium	Stainless Steel		
4319-3010	4319-5010	10 L	116
4319-3110	4319-5110	10 R	116
4319-3011	4319-5011	11 L	128
4319-3111	4319-5111	11 R	128
4319-3012	4319-5012	12 L	140
4319-3112	4319-5112	12 R	140
4319-3013	4319-5013	13 L	152
4319-3113	4319-5113	13 R	152
4319-3014	4319-5014	14 L	164
4319-3114	4319-5114	14 R	164
4319-3015	4319-5015	15 L	176
4319-3115	4319-5115	15 R	176
4319-3016	4319-5016	16 L	198
4319-3116	4319-5116	16 R	198
4319-3017	4319-5017	17 L	210
4319-3117	4319-5117	17 R	210
4319-3018	4319-5018	18 L	222
4319-3118	4319-5118	18 R	222
4319-3020	4319-5020	20 L	234
4319-3120	4319-5120	20 R	234
HA3.5,HB3.5 Note:Select HA3.5 and HB3.5 screws			

Cloverleaf Plate

4213-3/5003~4213-3/5008



Product No.		Holes	Length
Pure Titanium	Stainless Steel		
4213-3003	4213-5003	3	74
4213-3004	4213-5004	4	90
4213-3005	4213-5005	5	106
4213-3006	4213-5006	6	122
4213-3007	4213-5007	7	138
4213-3008	4213-5008	8	154
HA3.5,HB4 Note:Select HA3.5 and HB4 screws			

4315 | Distal Radius Plate

4315-3/5103~4315-3/5108



Product No.		Holes	Length
Pure Titanium	Stainless Steel		
4315-3103	4315-5103	3	48
4315-3104	4315-5104	4	60
4315-3105	4315-5105	5	72
4315-3106	4315-5106	6	84
4315-3107	4315-5107	7	96
4315-3108	4315-5108	8	108
HA3.5,HB3.5 Note:Select HA3.5 and HB3.5 screws			

4316 | Distal Radius Plate

4316-3/5203~4316-3/5306



Product No.		Holes	Length
Pure Titanium	Stainless Steel		
4316-3203	4316-5203	3 L	80
4316-3303	4316-5303	3 R	80
4316-3204	4316-5204	4 L	92
4316-3304	4316-5304	4 R	92
4316-3205	4316-5205	5 L	104
4316-3305	4316-5305	5 R	104
4316-3206	4316-5206	6 L	116
4316-3306	4316-5306	6 R	116
HA3.5,HB3.5 Note:Select HA3.5 and HB3.5 screws			

SMALL BONE PLATE

4318 | Proximal Ulnar Plate

4318-3/5104~4318-3/5208



Product No.		Holes	Length
Pure Titanium	Stainless Steel		
4318-3104	4318-5104	4 L	62
4318-3204	4318-5204	4 R	62
4318-3105	4318-5105	5 L	74
4318-3205	4318-5205	5 R	74
4318-3106	4318-5106	6 L	86
4318-3206	4318-5206	6 R	86
4318-3107	4318-5107	7 L	98
4318-3207	4318-5207	7 R	98
4318-3108	4318-5108	8 L	110
4318-3208	4318-5208	8 R	110

Note: Select HA3.5 and HB3.5 screws

4211 | Small T-Plate

4211-3/5003~4211-3/5107



Product No.		Holes	Length	Head Holes
Pure Titanium	Stainless Steel			
4211-3003	4211-5003	3	44	4
4211-3004	4211-5004	4	55	
4211-3005	4211-5005	5	66	
4211-3006	4211-5006	6	77	
4211-3007	4211-5007	7	88	3
4211-3103	4211-5103	3	50	
4211-3104	4211-5104	4	55	
4211-3105	4211-5105	5	66	
4211-3106	4211-5106	6	77	
4211-3107	4211-5107	7	88	

Note: Select HA3.5 and HB3.5 screws

4212 | Small T-Plates, Oblique

4212-3/5003~4212-3/5008



Product No.		Holes	Length
Pure Titanium	Stainless Steel		
4212-3003	4212-5003	3	53
4212-3004	4212-5004	4	64
4212-3005	4212-5005	5	75
4212-3006	4212-5006	6	86
4212-3007	4212-5007	7	97
4212-3008	4212-5008	8	108

Note: Select HA3.5 and HB3.5 screws

4322 | Clavicle Hook Plate

4322-3/5003~4322-3/5108



Product No.		Holes	Length
Pure Titanium	Stainless Steel		
4322-3003	4322-5003	3 L	87
4322-3103	4322-5103	3 R	87
4322-3004	4322-5004	4 L	87
4322-3104	4322-5104	4 R	87
4322-3005	4322-5005	5 L	99
4322-3105	4322-5105	5 R	99
4322-3006	4322-5006	6 L	111
4322-3106	4322-5106	6 R	111
4322-3007	4322-5007	7 L	123
4322-3107	4322-5107	7 R	123
4322-3008	4322-5008	8 L	135
4322-3108	4322-5108	8 R	135

Note: Select HA3.5 screws

SMALL BONE PLATE

4121 | S-Clavicular Plates

4121-3/5104~4121-3/5212



Product No.		Holes	Length
Pure Titanium	Stainless Steel		
4121-3104	4121-5104	4 L	46
4121-3204	4121-5204	4 R	46
4121-3105	4121-5105	5 L	57
4121-3205	4121-5205	5 R	57
4121-3106	4121-5106	6 L	69
4121-3206	4121-5206	6 R	69
4121-3107	4121-5107	7 L	81
4121-3207	4121-5207	7 R	81
4121-3108	4121-5108	8 L	92
4121-3208	4121-5208	8 R	92
4121-3109	4121-5109	9 L	105
4121-3209	4121-5209	9 R	105
4121-3110	4121-5110	10 L	116
4121-3210	4121-5210	10 R	116
4121-3111	4121-5111	11 L	128
4121-3211	4121-5211	11 R	128
4121-3112	4121-5112	12 L	140
4121-3212	4121-5212	12 R	140

Note: Select HA3.5 and HB3.5 screws

4221 | S-Clavicular Plates

4221-3/5106~4221-3/5212



Product No.		Holes	Length
Pure Titanium	Stainless Steel		
4221-3106	4221-5106	6 L	70
4221-3206	4221-5206	6 R	70
4221-3107	4221-5107	7 L	82
4221-3207	4221-5207	7 R	82
4221-3108	4221-5108	8 L	94
4221-3208	4221-5208	8 R	94
4221-3110	4221-5110	11 L	116
4221-3210	4221-5210	11 R	116
4221-3112	4221-5112	12 L	139
4221-3212	4221-5212	12 R	139

Note: Select HA3.5 and HB3.5 screws

T4100 | Small Bone Instrument (Standard)

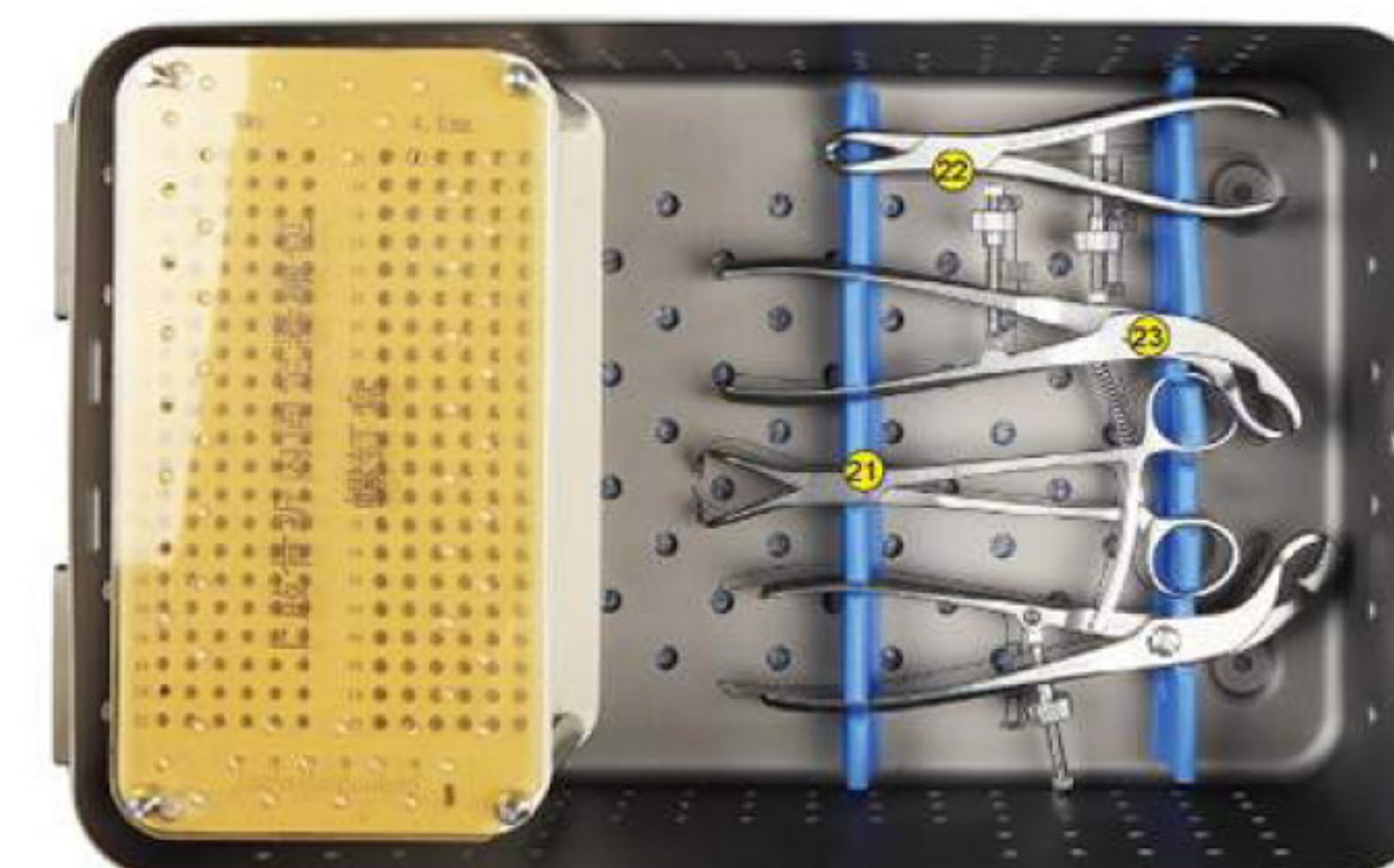
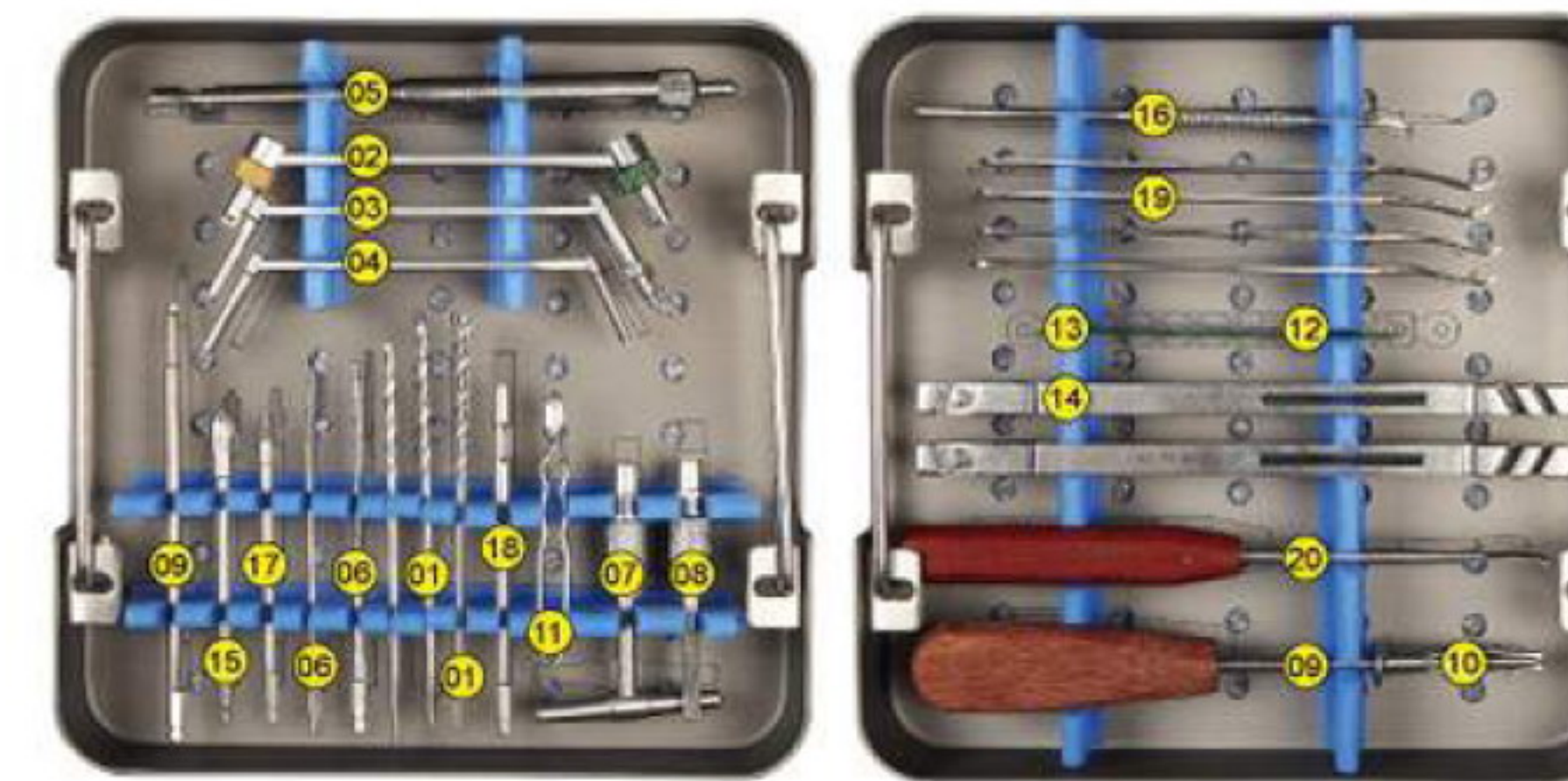

Product No.	Product Name	
T4100-0100		Drill Bit Φ2.5
T4100-0101	Φ3.5	Drill Bit Φ3.5
T4100-0200		DCP Drill Guide
T4100-0300		Drill Guide (Self-centering)
T4100-0400		Drill Guide
T4100-0500		Depth Gauge
T4100-0600		Screw Tap Φ3.5
T4100-0601	Φ4.0	Screw Tap Φ4.0
T4100-0700		Quick T-handle
T4100-0800		Quick Coupling
T4100-0900		Hexagonal Screwdriver SW2.5
T4100-0901		Hexagonal Screwdriver
T4100-1000		Screw Sleeve
T4100-1100		Screw Holding Forceps
T4100-1400		Bending Wrench
T4100-1500		Countersink Drill
T4100-1600		Sharp Hook
T4100-1700		Screw Anti-skidding Extractor
T4100-1800		Broken Screw Extractor
T4100-1900	6.5	Periosteum Elevator 6.5
T4100-1901		Periosteum Elevator 8.5
T4100-1902		Periosteum Elevator 11.5
T4100-2000		Periosteal Detacher
T4100-2100		Cusp Reduction Forceps
T4100-2200		Curved Reduction Forceps
T4100-2300		Centering Forceps

SMALL BONE PLATE

T4111
Small Bone Fracture Instrument Case (Large)



Product No.	Product Name
T4111-0100	Small Reduction Forceps
T4111-0200	Screw Holder
T4111-0300	Small Self-centering Forceps
T4111-0400	Cusp Small Reduction Forceps
T4111-0500	Depth Gauge
T4111-0600	Screw Driver(Hex)SW2.5
T4111-0700	Broken Screw Extractor
T4111-0800	Periosteal Elevator
T4111-0900	Tap HA3.5
T4111-0901	Tap HB4.0
T4111-1000	Double Head Drill Guide
T4111-1100	Drill Bit Φ2.5
T4111-1101	Drill Bit Φ3.0
T4111-1200	Screw Anti-skidding Extractor
T4111-1300	Drill Bit Guide
T4111-1301	Tap Guide
T4111-1400	Countersink Drill
T4111-1500	Plate Bending Wrench
T4111-1600	Screwdriver (Hex)

T4112
Small Bone Fracture Instrument Case (Small)

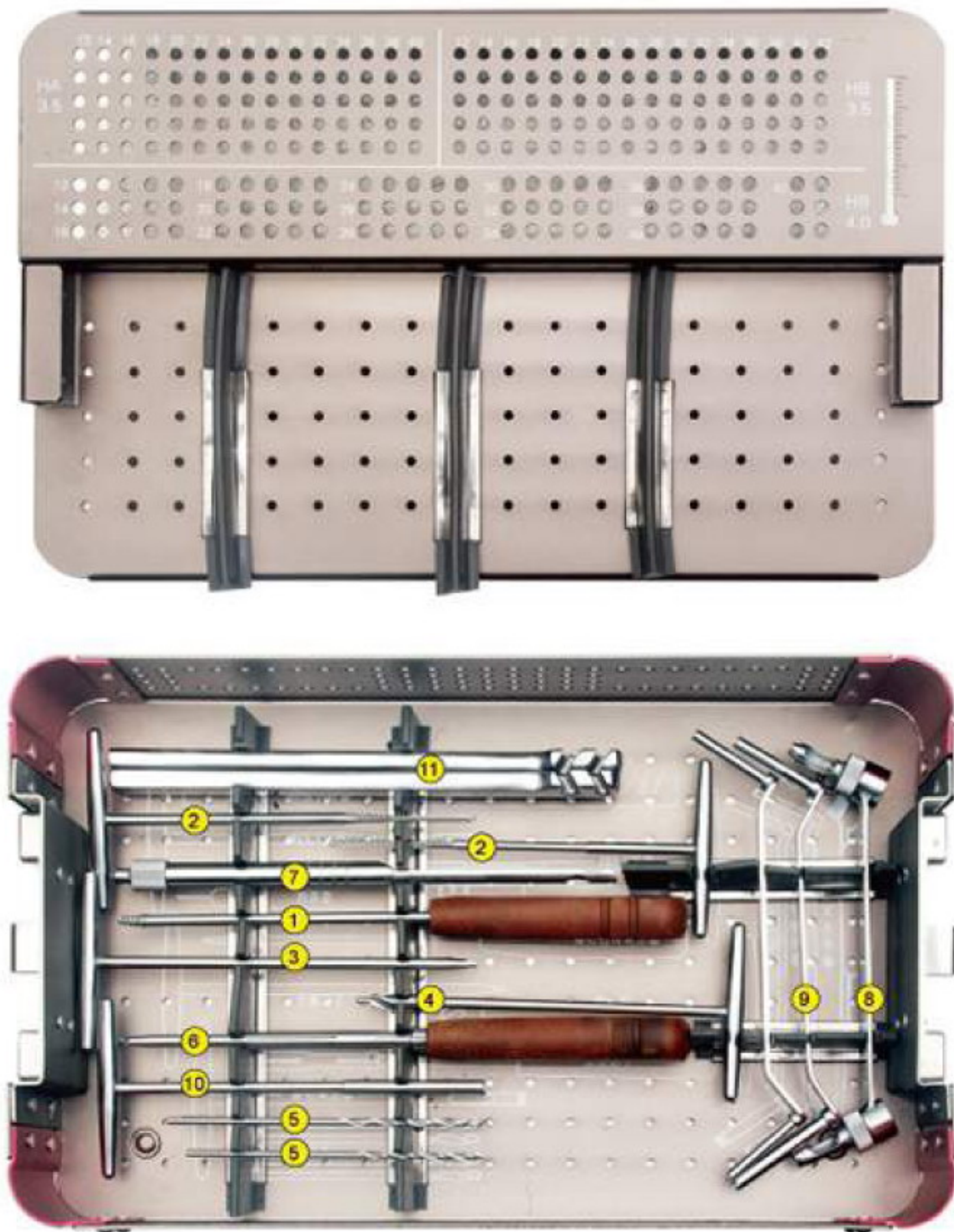

Product No.	Product Name
T4112-0100	Screw Anti-skidding Extractor
T4112-0200	Tap HA3.5
T4112-0201	Tap HB4.0
T4112-0300	Screw Driver(Hex)SW2.5
T4112-0400	Countersink Drill
T4112-0500	Drill Bit Φ2.5
T4112-0501	Drill Bit Φ3.0
T4112-0600	Screw Driver(Hex)SW2.5
T4112-0700	Depth Gauge
T4112-0800	Double Head Drill Guide
T4112-0900	Drill Guide
T4112-1000	Broken Screw Extractor
T4112-1100	Plate Bending Wrench

SMALL BONE LOCKING COMPRESSION PLATE(COMBINATION HOLE)

6129 |
LC-DCP Radius Locking Compression Plate
6129-3/5004~6129-3/5010

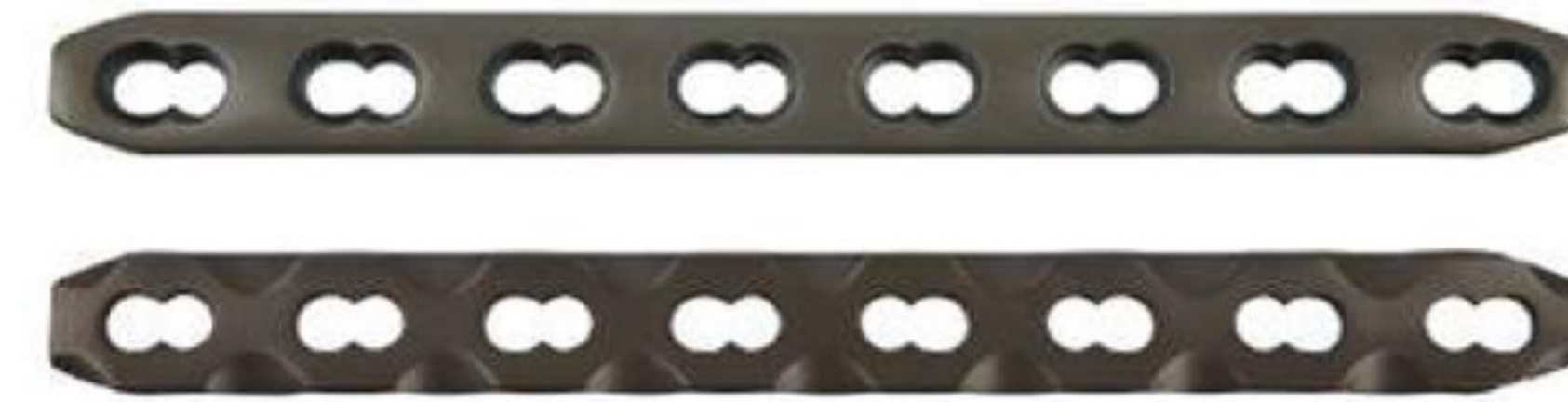

Product No.		Holes	Length
Pure Titanium	Stainless Steel		
6129-3004	6129-5004	4	58
6129-3005	6129-5005	5	71
6129-3006	6129-5006	6	84
6129-3007	6129-5007	7	97
6129-3008	6129-5008	8	110
6129-3009	6129-5009	9	123
6129-3010	6129-5010	10	136

Note:Select HC3.5 and HA3.5 screws

6130 |
LC-DCP Upper Limb Locking Compression Plate
6130-3/5104~6130-3/5011



Product No.		Holes	Length
Pure Titanium	Stainless Steel		
6130-3004	6130-5004	4	60
6130-3005	6130-5005	5	73
6130-3006	6130-5006	6	86
6130-3007	6130-5007	7	99
6130-3008	6130-5008	8	112
6130-3009	6130-5009	9	125
6130-3010	6130-5010	10	138
6130-3011	6130-5011	11	151

Note:Select HC3.5 and HA3.5 screws

6148 |
Reconstructio locking compression plate
6148-3/5005 ~ 6161-3/5018



Product No.		Holes	Length
Pure Titanium	Stainless Steel		
6148-3005	6148-5005	5	64
6148-3006	6148-5006	6	77
6148-3007	6148-5007	7	90
6148-3008	6148-5008	8	103
6148-3009	6148-5009	9	116
6148-3010	6148-5010	10	129
6148-3011	6148-5011	11	142
6148-3012	6148-5012	12	155
6148-3013	6148-5013	13	168
6148-3014	6148-5014	14	181
6148-3015	6148-5015	15	194
6148-3016	6148-5016	16	207

Note:Select HC3.5 and HA3.5 screws

6161 |
Metaphyseal Plate
6161-3/5006 ~ 6161-3/5018



Product No.		Holes	Length
Pure Titanium	Stainless Steel		
6161-3006	6161-5006	6	86
6161-3007	6161-5007	7	99
6161-3008	6161-5008	8	112
6161-3009	6161-5009	9	125
6161-3010	6161-5010	10	138
6161-3011	6161-5011	11	151
6161-3012	6161-5012	12	164
6161-3013	6161-5013	13	177
6161-3014	6161-5014	14	190
6161-3015	6161-5015	15	203
6161-3016	6161-5016	16	216
6161-3017	6161-5017	17	229
6161-3018	6161-5018	18	242

Note:Select HC3.5 and HA3.5 screws

6355 |
Proximal Humeral Locking Compression Plate
6355-3/5004~6355-3/5010



Product No.		Holes	Length
Pure Titanium	Stainless Steel		
6355-3004	6355-5004	4	79
6355-3005	6355-5005	5	92
6355-3006	6355-5006	6	105
6355-3007	6355-5007	7	118
6355-3008	6355-5008	8	131
6355-3009	6355-5009	9	144
6355-3010	6355-5010	10	157

Note: Select HC3.5 and HA3.5 screws

6357 |
Proximal Humeral Locking Compression Plate
6357-3/5104~6357-3/5209



Product No.		Holes	Length
Pure Titanium	Stainless Steel		
6357-3104	6357-5104	4 L	94
6357-3204	6357-5204	4 R	94
6357-3105	6357-5105	5 L	107
6357-3205	6357-5205	5 R	107
6357-3106	6357-5106	6 L	120
6357-3206	6357-5206	6 R	120
6357-3107	6357-5107	7 L	133
6357-3207	6357-5207	7 R	133
6357-3108	6357-5108	8 L	146
6357-3208	6357-5208	8 R	146
6357-3109	6357-5109	9 L	159
6357-3209	6357-5209	9 R	159

Note: Select HC3.5 and HA3.5 screws

6394 |
Proximal Humeral Lateral Locking Compression Plate
6394-3/5004~6394-3/5009



Product No.		Holes	Length
Pure Titanium	Stainless Steel		
6394-3004	6394-5004	4	124
6394-3005	6394-5005	5	139
6394-3006	6394-5006	6	154
6394-3007	6394-5007	7	169
6394-3008	6394-5008	8	184
6394-3009	6394-5009	9	199

Note: Select HC3.5 and HA3.5 screws

6351 |
Distal Humeral Lateral Locking Compression Plate (Condylar)
6351-3/5103~6351-3/5209



Product No.		Holes	Length
Pure Titanium	Stainless Steel		
6351-3103	6351-5103	3 L	62
6351-3203	6351-5203	3 R	62
6351-3104	6351-5104	4 L	75
6351-3204	6351-5204	4 R	75
6351-3105	6351-5105	5 L	88
6351-3205	6351-5205	5 R	88
6351-3106	6351-5106	6 L	101
6351-3206	6351-5206	6 R	101
6351-3107	6351-5107	7 L	114
6351-3207	6351-5207	7 R	114
6351-3108	6351-5108	8 L	127
6351-3208	6351-5208	8 R	127
6351-3109	6351-5109	9 L	140
6351-3209	6351-5209	9 R	140

Note: Select HC2.5, HC3.5 and HA3.5 screws

6350 |
Distal Humeral Medial Locking Compression Plate
6350-3/5103~6350-3/5209



Product No.		Holes	Length
Pure Titanium	Stainless Steel		
6350-3103	6350-5103	3 L	62
6350-3203	6350-5203	3 R	62
6350-3104	6350-5104	4 L	75
6350-3204	6350-5204	4 R	75
6350-3105	6350-5105	5 L	88
6350-3205	6350-5205	5 R	88
6350-3106	6350-5106	6 L	101
6350-3206	6350-5206	6 R	101
6350-3107	6350-5107	7 L	114
6350-3207	6350-5207	7 R	114
6350-3108	6350-5108	8 L	127
6350-3208	6350-5208	8 R	127
6350-3109	6350-5109	9 L	140
6350-3209	6350-5209	9 R	140

Note: Select HC2.5, HC3.5 and HA3.5 screws

6221 |
Distal Radius Medial Locking Compression Plate
6221-3/5003~6221-3/5005



Product No.		Holes	Length
Pure Titanium	Stainless Steel		
6221-3003	6221-5003	3	47
6221-3004	6221-5004	4	59
6221-3005	6221-5005	5	71

Note: Select HC2.5, HA2.5 and HA2.7 screws

6230 |
Distal Radius Lateral Locking Compression Plate
6230-3/5004~6230-3/5007



Product No.		Holes	Length
Pure Titanium	Stainless Steel		
6230-3004	6230-5004	4	44.5
6230-3005	6230-5005	5	53.5
6230-3006	6230-5006	6	59
6230-3007	6230-5007	7	68

Note: Select HC2.5, HA2.5 and HA2.7 screws

6231 |
Distal Radius Lateral L-Locking Compression Plate
6231-3/5103~6231-3/5205



Product No.		Holes	Length
Pure Titanium	Stainless Steel		
6231-3103	6231-5103	3 L	42
6231-3203	6231-5203	3 R	42
6231-3104	6231-5104	4 L	52
6231-3204	6231-5204	4 R	52
6231-3105	6231-5105	5 L	62
6231-3205	6231-5205	5 R	62

Note: Select HC2.5, HA2.5 and HA2.7 screws

6232 |
Distal Radius Lateral L-Locking Compression Plate
6232-3/5103~6232-3/5205



Product No.		Holes	Length
Pure Titanium	Stainless Steel		
6232-3103	6232-5103	3 L	42
6232-3203	6232-5203	3 R	42
6232-3104	6232-5104	4 L	52
6232-3204	6232-5204	4 R	52
6232-3105	6232-5105	5 L	62
6232-3205	6232-5205	5 R	62

Note: Select HC2.5, HA2.5 and HA2.7 screws

SMALL BONE LOCKING COMPRESSION PLATE(COMBINATION HOLE)

SMALL BONE LOCKING COMPRESSION PLATE(COMBINATION HOLE)

6233 |
Distal Radius Lateral Oblique L-Locking Compression Plate
6233-3/5103-6233-3/5205



Product No.		Holes	Length
Pure Titanium	Stainless Steel		
6233-3103	6233-5103	3 L	45
6233-3203	6233-5203	3 R	45
6233-3104	6233-5104	4 L	55
6233-3204	6233-5204	4 R	55
6233-3105	6233-5105	5 L	65
6233-3205	6233-5205	5 R	65

Note: Select HC2.5, HA2.5 and HA2.7 screws

6237 |
Distal Radius Medial Locking Compression Plate
6237-3/5103-6237-3/5207



Product No.		Holes	Length
Pure Titanium	Stainless Steel		
6237-3103	6237-5103	3 L	50
6237-3203	6237-5203	3 R	50
6237-3104	6237-5104	4 L	60
6237-3204	6237-5204	4 R	60
6237-3105	6237-5105	5 L	70
6237-3205	6237-5205	5 R	70
6237-3106	6237-5106	6 L	80
6237-3206	6237-5206	6 R	80
6237-3107	6237-5107	7 L	90
6237-3207	6237-5207	7 R	90

Note: Select HC2.5, HA2.5 and HA2.7 screws

6234 |
Distal Radius Lateral Oblique L-Locking Compression Plate
6234-3/5103-6234-3/5205



Product No.		Holes	Length
Pure Titanium	Stainless Steel		
6234-3103	6234-5103	3 L	47
6234-3203	6234-5203	3 R	47
6234-3104	6234-5104	4 L	57
6234-3204	6234-5204	4 R	57
6234-3105	6234-5105	5 L	67
6234-3205	6234-5205	5 R	67

Note: Select HC2.5, HA2.5 and HA2.7 screws

6290 |



Product No.		Holes	Length
Pure Titanium	Stainless Steel		
6290-3102	6290-5102	2 L	36
6290-3202	6290-5202	2 R	36
6290-3103	6290-5103	3 L	46
6290-3203	6290-5203	3 R	46
6290-3104	6290-5104	4 L	55
6290-3204	6290-5204	4 R	55
6290-3105	6290-5105	5 L	65
6290-3205	6290-5205	5 R	65

Note: Select HC2.5, HA2.5 and HA2.7 screws

6235 |
Distal Radius Medial Locking Compression Plate
6235-3/5103-6235-3/5207



Product No.		Holes	Length
Pure Titanium	Stainless Steel		
6235-3103	6235-5103	3 L	46
6235-3203	6235-5203	3 R	46
6235-3104	6235-5104	4 L	56
6235-3204	6235-5204	4 R	56
6235-3105	6235-5105	5 L	66
6235-3205	6235-5205	5 R	66
6235-3106	6235-5106	6 L	76
6235-3206	6235-5206	6 R	76
6235-3107	6235-5107	7 L	86
6235-3207	6235-5207	7 R	86

Note: Select HC2.5, HA2.5 and HA2.7 screws

6248-3/5102 ~ 6248-3/5205
Distal Radius Medial Locking Compression Plate (head with 6 holes)



Product No.		Holes	Length
Pure Titanium	Stainless Steel		
6248-3102	6248-5102	2 L	44
6248-3202	6248-5202	2 R	44
6248-3103	6248-5103	3 L	53
6248-3203	6248-5203	3 R	53
6248-3104	6248-5104	4 L	64
6248-3204	6248-5204	4 R	64
6248-3105	6248-5105	5 L	72
6248-3205	6248-5205	5 R	72

Note: Select HC2.5, HA2.5 and HA2.7 screws

6236 |
Distal Radius Lateral T-Locking Compression Plate
6236-3/5003-6236-3/5007



Product No.		Holes	Length
Pure Titanium	Stainless Steel		
6236-3003	6236-5003	3	42
6236-3004	6236-5004	4	52
6236-3005	6236-5005	5	62
6236-3006	6236-5006	6	72
6236-3007	6236-5007	7	82

Note: Select HC2.5, HA2.5 and HA2.7 screws

6249-3/5102 ~ 6249-3/5205
Distal Radius Medial Locking Compression Plate (head with 7 holes)



Product No.		Holes	Length
Pure Titanium	Stainless Steel		
6249-3102	6249-5102	2 L	49
6249-3202	6249-5202	2 R	49
6249-3103	6249-5103	3 L	57
6249-3203	6249-5203	3 R	57
6249-3104	6249-5104	4 L	68
6249-3204	6249-5204	4 R	68
6249-3105	6249-5105	5 L	76
6249-3205	6249-5205	5 R	76

Note: Select HC2.5, HA2.5 and HA2.7 screws

6349 |
Proximal Ulnar Radius Locking Compression Plate
6349-3/5104~6349-3/5211



Product No.		Holes	Length
Pure Titanium	Stainless Steel		
6349-3104	6349-5104		123
6349-3204	6349-5204	4 R	123
6349-3105	6349-5105	5 L	136
6349-3205	6349-5205	5 R	136
6349-3106	6349-5106	6 L	149
6349-3206	6349-5206	6 R	149
6349-3107	6349-5107	7 L	162
6349-3207	6349-5207	7 R	162
6349-3108	6349-5108	8 L	175
6349-3208	6349-5208	8 R	175
6349-3109	6349-5109	9 L	188
6349-3209	6349-5209	9 R	188
6349-3110	6349-5110	10 L	201
6349-3210	6349-5210	10 R	201
6349-3111	6349-5111	11 L	214
6349-3211	6349-5211	11 R	214

Note: Select HC3.5 and HA3.5 screws

6364 |
Clavicle Hook Locking Compression Plate
6364-3/5104~6364-3/5207



Product No.		Holes	Height
Pure Titanium	Stainless Steel		
6364-3104	6364-5104	4 L	17
6364-3204	6364-5204	4 R	
6364-3105	6364-5105	5 L	20
6364-3205	6364-5205	5 R	
6364-3106	6364-5106	6 L	23
6364-3206	6364-5206	6 R	
6364-3107	6364-5107	7 L	
6364-3207	6364-5207	7 R	

Note: Select HC3.5 and HA3.5 screws

6393 |
Clavicle Lateral Locking Compression Plate
6393-3/5103~6393-3/5208



Product No.		Holes	Length
Pure Titanium	Stainless Steel		
6393-3103	6393-5103	3 L	62
6393-3203	6393-5203	3 R	62
6393-3104	6393-5104	4 L	78
6393-3204	6393-5204	4 R	78
6393-3105	6393-5105	5 L	93
6393-3205	6393-5205	5 R	93
6393-3106	6393-5106	6 L	108
6393-3206	6393-5206	6 R	108
6393-3107	6393-5107	7 L	123
6393-3207	6393-5207	7 R	123
6393-3108	6393-5108	8 L	136
6393-3208	6393-5208	8 R	136
6393-3109	6393-5109	9 L	149
6393-3209	6393-5109	9 R	149

Note: Select HC2.5, HC3.5 and HA3.5 screws

6124 |
S-clavicle Locking compression Plate
6124-3/5106~6124-3/5210



Product No.		Holes	Length
Pure Titanium	Stainless Steel		
6124-3106	6124-5106	6 L	95
6124-3206	6124-5206	6 R	95
6124-3108	6124-5108	8 L	122
6124-3208	6124-5208	8 R	122
6124-3110	6124-5110	10 L	147
6124-3210	6124-5210	10 R	147

Note: Select HC3.5 and HA3.5 screws

6122 |
LC-DCP Ulnar / Radius / Fibula Locking Compression Plate
6122-3/5004~6122-3/5012



Product No.		Holes	Length
Pure Titanium	Stainless Steel		
6122-3004	6122-5004	4	51
6122-3005	6122-5005	5	64
6122-3006	6122-5006	6	77
6122-3007	6122-5007	7	90
6122-3008	6122-5008	8	103
6122-3009	6122-5009	9	116
6122-3010	6122-5010	10	129
6122-3011	6122-5011	11	142
6122-3012	6122-5012	12	155

Note: Select HC3.5 and HA3.5 screws

6112 |
LC-DCP Upper Limb Locking Compression Plate
6112-3/5004~6112-3/5012



Product No.		Holes	Length
Pure Titanium	Stainless Steel		
6112-3004	6112-5004	4	68
6112-3005	6112-5005	5	81
6112-3006	6112-5006	6	94
6112-3007	6112-5007	7	107
6112-3008	6112-5008	8	120
6112-3009	6112-5009	9	133
6112-3010	6112-5010	10	146
6112-3011	6112-5011	11	159
6112-3012	6112-5012	12	172

Note: Select HC3.5 and HA3.5 screws

6117-3/5003~6117-3/5010
1/2 Tubular Locking Plate



Product No.		Holes	Length
Pure Titanium	Stainless Steel		
6117-3003	6117-5003	3	47
6117-3004	6117-5004	4	59
6117-3005	6117-5005	5	71
6117-3006	6117-5006	6	83
6117-3007	6117-5007	7	95
6117-3008	6117-5008	8	107
6117-3009	6117-5009	9	119
6117-3010	6117-5010	10	131

Note: Select HC3.5 screws

6118-3/5004~6118-3/5012
1/3 Tubular Locking Plate



Product No.		Holes	Length
Pure Titanium	Stainless Steel		
6118-3004	6118-5004	4	49
6118-3005	6118-5005	5	61
6118-3006	6118-5006	6	73
6118-3007	6118-5007	7	85
6118-3008	6118-5008	8	97
6118-3009	6118-5009	9	109
6118-3010	6118-5010	10	121
6118-3011	6118-5011	11	133
6118-3012	6118-5012	12	145

Note: Select HC3.5 screws

SMALL BONE LOCKING PLATE(ROUND HOLE)

6119 |
Reconstruction Locking Plate
6119-3/5004~6119-3/5014



Product No.		Holes	Length
Pure Titanium	Stainless Steel		
6119-3004	6119-5004	4	48
6119-3005	6119-5005	5	60
6119-3006	6119-5006	6	72
6119-3007	6119-5007	7	84
6119-3008	6119-5008	8	96
6119-3009	6119-5009	9	108
6119-3010	6119-5010	10	120
6119-3011	6119-5011	11	132
6119-3012	6119-5012	12	144
6119-3013	6119-5013	13	156
6119-3014	6119-5014	14	168

Note:Select HC3.5 screws

6120 |
Clavicular Locking Plate
6120-3/5005~6120-3/5016



Product No.		Holes	Length
Pure Titanium	Stainless Steel		
6120-3005	6120-5005	5	58
6120-3006	6120-5006	6	70
6120-3007	6120-5007	7	82
6120-3008	6120-5008	8	94
6120-3009	6120-5009	9	106
6120-3010	6120-5010	10	118
6120-3011	6120-5011	11	130
6120-3012	6120-5012	12	142
6120-3013	6120-5013	13	154
6120-3014	6120-5014	14	166
6120-3015	6120-5015	15	178
6120-3016	6120-5016	16	190

Note:Select HC3.5 screws

6312 |
Proximal Humeral Lateral Locking Compression Plate
6312-3/5004~6312-3/5010



Product No.		Holes	Length
Pure Titanium	Stainless Steel		
6312-3004	6312-5004	4	76
6312-3005	6312-5005	5	88
6312-3006	6312-5006	6	100
6312-3007	6312-5007	7	112
6312-3008	6312-5008	8	124
6312-3009	6312-5009	9	136
6312-3010	6312-5010	10	148

Note:Select HC3.5 screws

6313 |
Proximal Humeral Lateral Locking Compression Plate
6613-3/5004~6613-3/5112



Product No.		Holes	Length
Pure Titanium	Stainless Steel		
6313-3004	6313-5004	4 L	90
6313-3104	6313-5104	4 R	90
6313-3005	6313-5005	5 L	102
6313-3105	6313-5105	5 R	102
6313-3006	6313-5006	6 L	114
6313-3106	6313-5106	6 R	114
6313-3007	6313-5007	7 L	126
6313-3107	6313-5107	7 R	126
6313-3008	6313-5008	8 L	138
6313-3108	6313-5108	8 R	138
6313-3009	6313-5009	9 L	150
6313-3109	6313-5109	9 R	150
6313-3010	6313-5010	10 L	162
6313-3110	6313-5110	10 R	162
6313-3012	6313-5012	12 L	186
6313-3112	6313-5112	12 R	186

Note:Select HC3.5 and HA3.5 screws

SMALL BONE LOCKING PLATE(ROUND HOLE)

6311 |
Proximal Humeral Lateral Locking compression Plate
6311-3/5102~6311-3/5112



Product No.		Holes	Length
Pure Titanium	Stainless Steel		
6311-3102	6311-5102	2	94
6311-3103	6311-5103	3	109
6311-3104	6311-5104	4	124
6311-3105	6311-5105	5	139
6311-3106	6311-5106	6	154
6311-3107	6311-5107	7	169
6311-3108	6311-5108	8	184
6311-3109	6311-5109	9	199
6311-3110	6311-5110	10	214
6311-3111	6311-5111	11	229
6311-3112	6311-5112	12	244

Note:Select HC3.5 and HA3.5 screws

6319 |
Distal Humeral Lateral Locking Plates
6319-3/5112~6319-3/5218



Product No.		Holes	Length
Pure Titanium	Stainless Steel		
6319-3112	6319-5112	12 L	140
6319-3212	6319-5212	12 R	140
6319-3113	6319-5113	13 L	152
6319-3213	6319-5213	13 R	152
6319-3114	6319-5114	14 L	164
6319-3214	6319-5214	14 R	164
6319-3115	6319-5115	15 L	176
6319-3215	6319-5215	15 R	176
6319-3116	6319-5116	16 L	198
6319-3216	6319-5216	16 R	198
6319-3117	6319-5117	17 L	210
6319-3217	6319-5217	17 R	210
6319-3118	6319-5118	18 L	222
6319-3218	6319-5218	18 R	222

Note:Select HC3.5 and HA3.5 screws

6320 |
Distal Humeral Locking Plates
6320-3/5008~6320-3/5016



Product No.		Holes	Length
Pure Titanium	Stainless Steel		
6320-3008	6320-5008	8	72
6320-3009	6320-5009	9	82
6320-3010	6320-5010	10	92
6320-3011	6320-5011	11	102
6320-3012	6320-5012	12	112
6320-3013	6320-5013	13	122
6320-3014	6320-5014	14	132
6320-3015	6320-5015	15	142
6320-3016	6320-5016	16	152

Note:Select HC3.5 screws

6211 |
Small T-Locking Compression Plate
6211-3/5003~6211-3/5008



Product No.		Holes	Length	Head Holes	
Pure Titanium	Stainless Steel				
6211-3003	6211-5003	3	50	4	
6211-3004	6211-5004	4	62		
6211-3005	6211-5005	5	75		
6211-3006	6211-5006	6	87		
6211-3007	6211-5007	7	99		
6211-3103	6211-5103	3	56		3
6211-3104	6211-5104	4	67		
6211-3105	6211-5105	5	78		
6211-3106	6211-5106	6	89		
6211-3107	6211-5107	7	100		

Note:Select HC3.5 and HA3.5 screws

SMALL BONE LOCKING PLATE(ROUND HOLE)

6212 | Small T-Locking Compression Plate,Oblique
6212-3/5103-6212-3/5208



Product No.		Holes	Length
Pure Titanium	Stainless Steel		
6212-3103	6212-5103	3 L	53
6212-3203	6212-5203	3 R	53
6212-3104	6212-5104	4 L	64
6212-3204	6212-5204	4 R	64
6212-3105	6212-5105	5 L	75
6212-3205	6212-5205	5 R	75
6212-3106	6212-5106	6 L	86
6212-3206	6212-5206	6 R	86
6212-3107	6212-5107	7 L	97
6212-3207	6212-5207	7 R	97
6212-3108	6212-5108	8 L	108
6212-3208	6212-5208	8 R	108

Note:Select HC3.5 and HA3.5 screws

6315 | Distal Radius Medial Locking Compression Plate
6315-3/5103-6315-3/5108



Product No.		Holes	Length
Pure Titanium	Stainless Steel		
6315-3103	6315-5103	3	49
6315-3104	6315-5104	4	61
6315-3105	6315-5105	5	73
6315-3106	6315-5106	6	85
6315-3107	6315-5107	7	97
6315-3108	6315-5108	8	109

Note:Select HC3.5 and HA3.5 screws

6318 | Ulnar Locking Plate
6318-3/5104-6318-3/5208



Product No.		Holes	Length
Pure Titanium	Stainless Steel		
6318-3104	6318-5104	4 L	80
6318-3204	6318-5204	4 R	80
6318-3105	6318-5105	5 L	95
6318-3205	6318-5205	5 R	95
6318-3106	6318-5106	6 L	110
6318-3206	6318-5206	6 R	110
6318-3107	6318-5107	7 L	125
6318-3207	6318-5207	7 R	125
6318-3108	6318-5108	8 L	140
6318-3208	6318-5208	8 R	140

Note:Select HC3.5 and HA3.5 screws

6322 | Clavicular Locking Plate
6322-3/5103-6322-3/5207



Product No.		Holes	Height
Pure Titanium	Stainless Steel		
6322-3103	6322-5103	3 L	17
6322-3203	6322-5203	3 R	
6322-3104	6322-5104	4 L	20
6322-3204	6322-5204	4 R	
6322-3105	6322-5105	5 L	23
6322-3205	6322-5205	5 R	
6322-3106	6322-5106	6 L	23
6322-3206	6322-5206	6 R	
6322-3107	6322-5107	7 L	
6322-3207	6322-5207	7 R	

Note:Select HC3.5 screws

SMALL BONE LOCKING PLATE(ROUND HOLE)

6121 | S-Clavicular Locking Plate
6121-3/5106-6121-3/5212



6123 | S-Clavicular Locking Plate
6123-3/5104-6123-3/5212



6213 | Cloverleaf Locking Compression Plate
6213-3/5003-6213-3/5010



T6112 | Large Bone Fracture Instrument Case (Small)

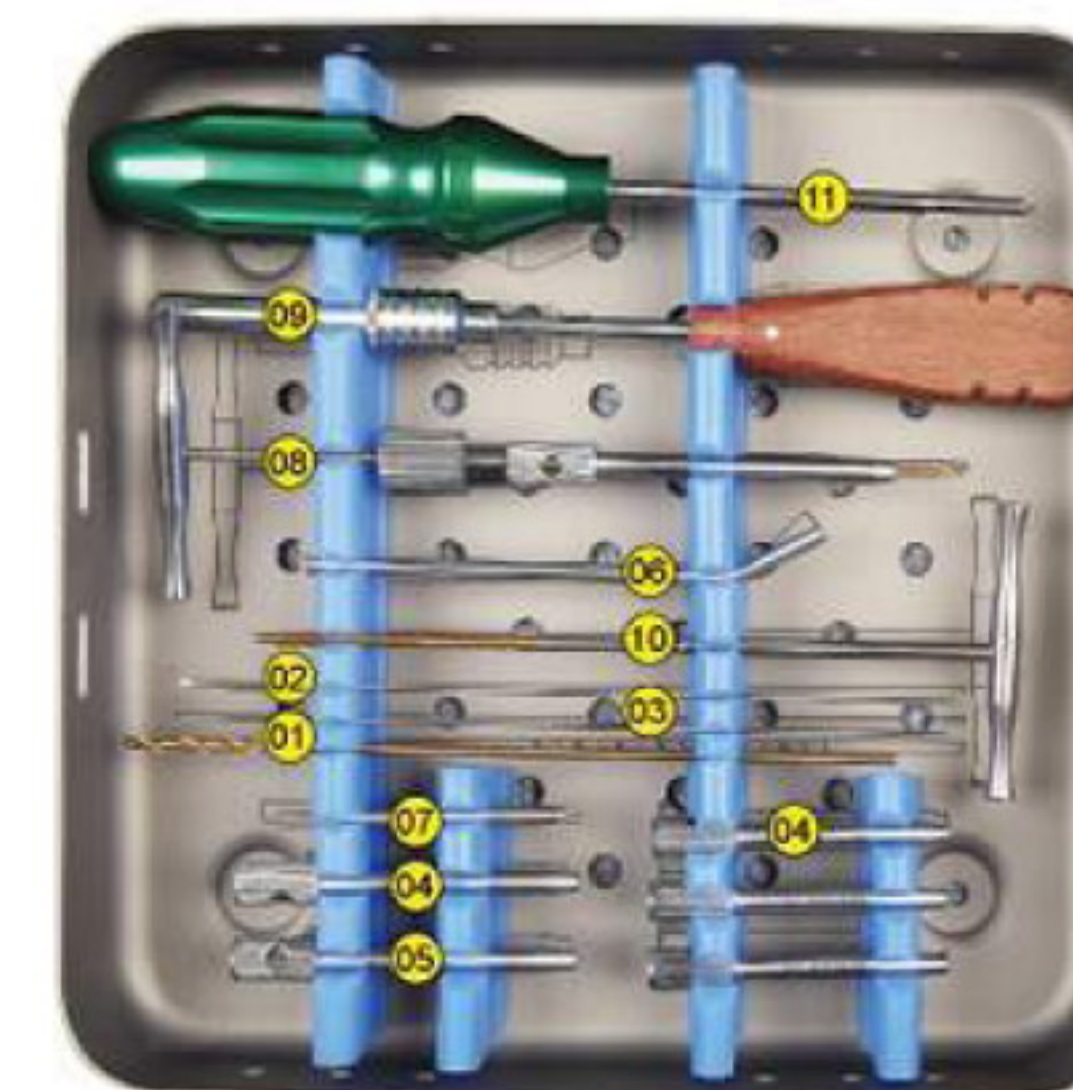

Product No.		Holes	Length
Pure Titanium	Stainless Steel		
6121-3106	6121-5106	6 L	68
6121-3206	6121-5206	6 R	68
6121-3108	6121-5108	8 L	92
6121-3208	6121-5208	8 R	92
6121-3110	6121-5110	10 L	116
6121-3210	6121-5210	10 R	116
6121-3112	6121-5112	12 L	140
6121-3212	6121-5212	12 R	140

Note:Select HC3.5 screws

Product No.		Holes	Length
Pure Titanium	Stainless Steel		
6123-3104	6123-5104	4 L	46
6123-3204	6123-5204	4 R	46
6123-3105	6123-5105	5 L	57
6123-3205	6123-5205	5 R	57
6123-3106	6123-5106	6 L	69
6123-3206	6123-5206	6 R	69
6123-3107	6123-5107	7 L	80
6123-3207	6123-5207	7 R	80
6123-3108	6123-5108	8 L	92
6123-3208	6123-5208	8 R	92
6123-3109	6123-5109	9 L	104
6123-3209	6123-5209	9 R	104
6123-3110	6123-5110	10 L	116
6123-3210	6123-5210	10 R	116
6123-3111	6123-5111	11 L	128
6123-3211	6123-5211	11 R	128
6123-3112	6123-5112	12 L	139
6123-3212	6123-5212	12 R	139

Note:Select HC3.5 screws

Product No.		Holes	Length
Pure Titanium	Stainless Steel		
6213-3003	6213-5003	3	74
6213-3004	6213-5004	4	90
6213-3005	6213-5005	5	106
6213-3006	6213-5006	6	122
6213-3007	6213-5007	7	138
6213-3008	6213-5008	8	154
6213-3009	6213-5009	9	170
6213-3010	6213-5010	10	186

Note:Select HC3.5 and HA3.5 screws

Product No.	Product Name	
T6112-0100	Φ2.5	Drill Bit Φ2.5
T6112-0200	Φ1.5	Threaded Guide PinΦ1.5
T6112-0300	Φ1.5*150	Guide Pin
T6112-0400		LCP Drill Guide Sleeve
T6112-0500		LCP Kirscher Wire Guide Sleeve
T6112-0600		Wrench Bar
T6112-0700		Electro-Stardrive Screwdriver
T6112-0800		T-Drill
T6112-0900		Screw Holder
T6112-1000	HA3.5	Screw Tap HA3.5
T6112-1100		Torque Limiting Screwdriver

SMALL BONE LOCKING PLATE(ROUND HOLE)

LARGE BONE PLATE

T6111
Small Bone Fracture Locking Plate Instrument (Large)

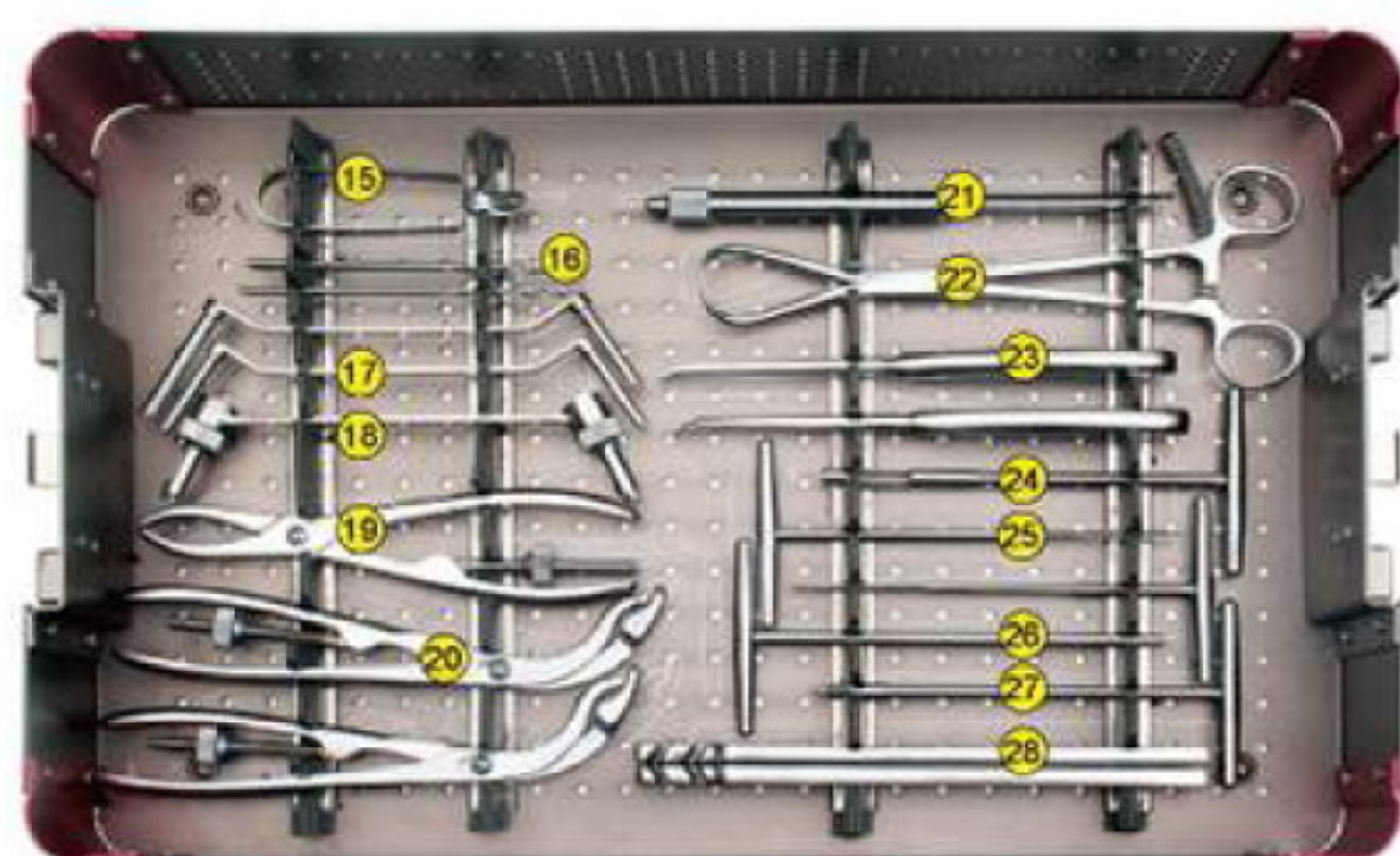
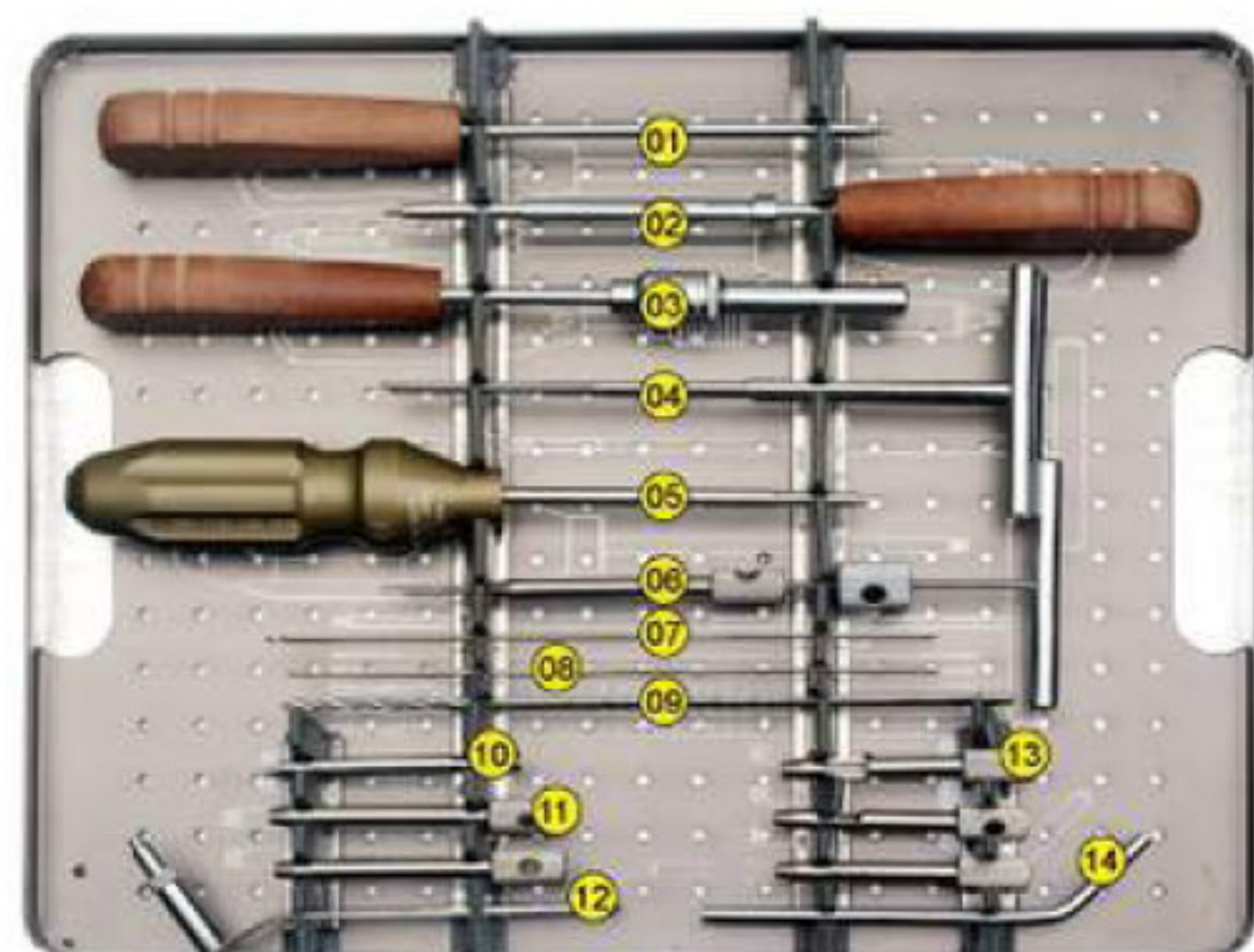

Product No.	Product Name	
T6111-0100		Screw Anti-skidding Extractor
T6111-0200		Protected Screw Driver SW2.5
T6111-0300		Protected Star Screw Driver
T6111-0400		Locking Screw Tap
T6111-0500		Torque Limited Star Screw Driver
T6111-0600		T-Drill
T6111-0700		Guide Pin
T6111-0800		Guide PinΦ1.5*150
T6111-0900		Drill BitΦ2.8*180
T6111-1000		Elector-Star Screw Driver
T6111-1100		LCP Kirscher Wire Guide Sleeve
T6111-1200		Drill Guide
T6111-1300		LCP Drill Guide Sleeve
T6111-1400		Wrench Bar
T6111-1500		Screw Holder Forceps
T6111-1600		Drill Bit Φ2.5
T6111-1601		Drill Bit Φ3.0
T6111-1700		Drill GuideΦ2.5
T6111-1800		Double Head Drill GuideΦ2.5(Mid/offcenter)
T6111-1900		Bone Holding Forcep (Small)
T6111-2000		Small Self-centering Forceps
T6111-2100		Depth Gauge
T6111-2200		Small Pointed Reduction Forceps
T6111-2300		Periosteum Detacher
T6111-2400		Broken Screw Extractor
T6111-2500		Screw Tap HA3.5
T6111-2600		Protected Screw Driver SW2.5
T6111-2700		Countersink Drill Φ8mm
T6111-2800		Plate Bending Wrench

T6230 2.5
2.5 Distal Radius LCP Instrument Set

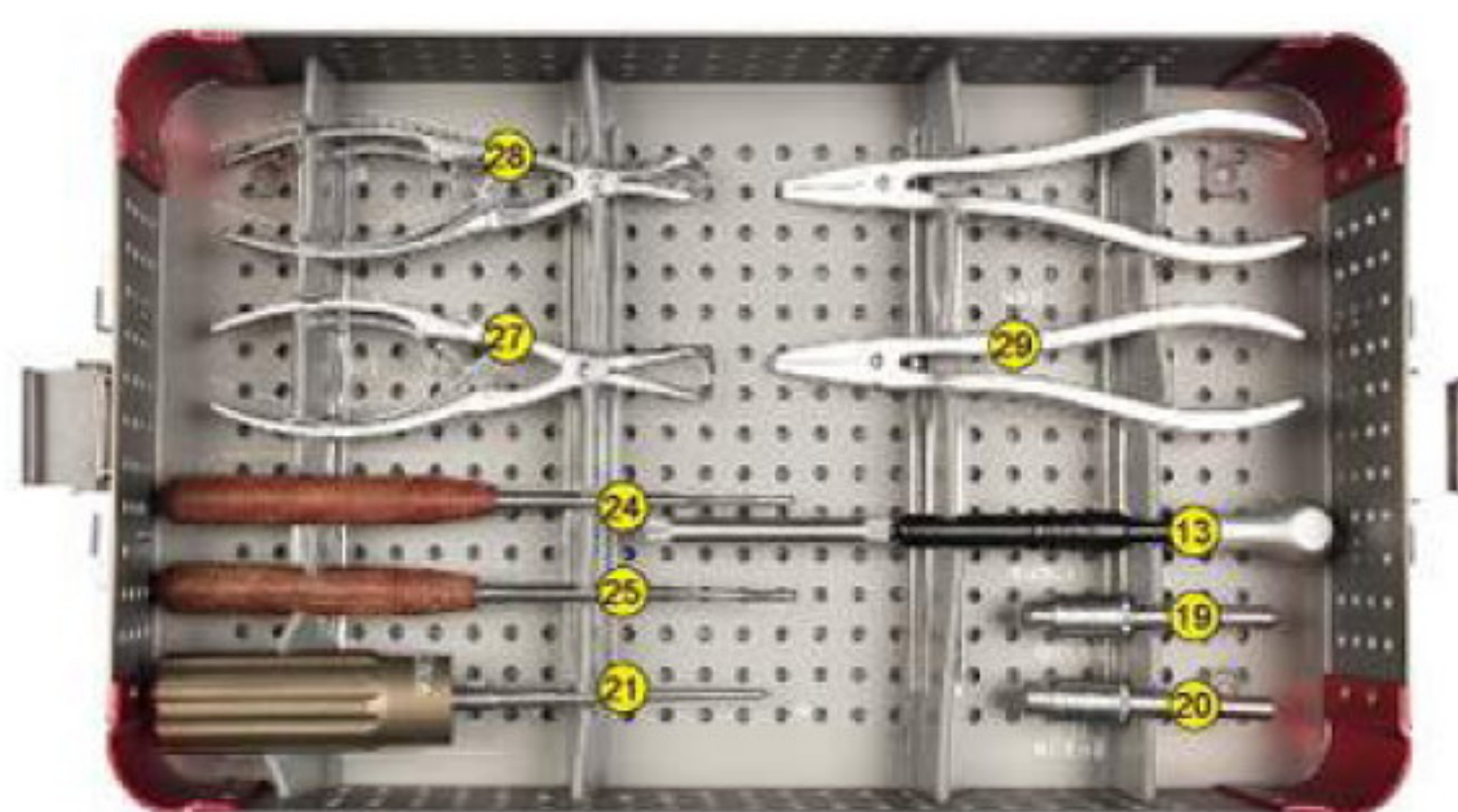
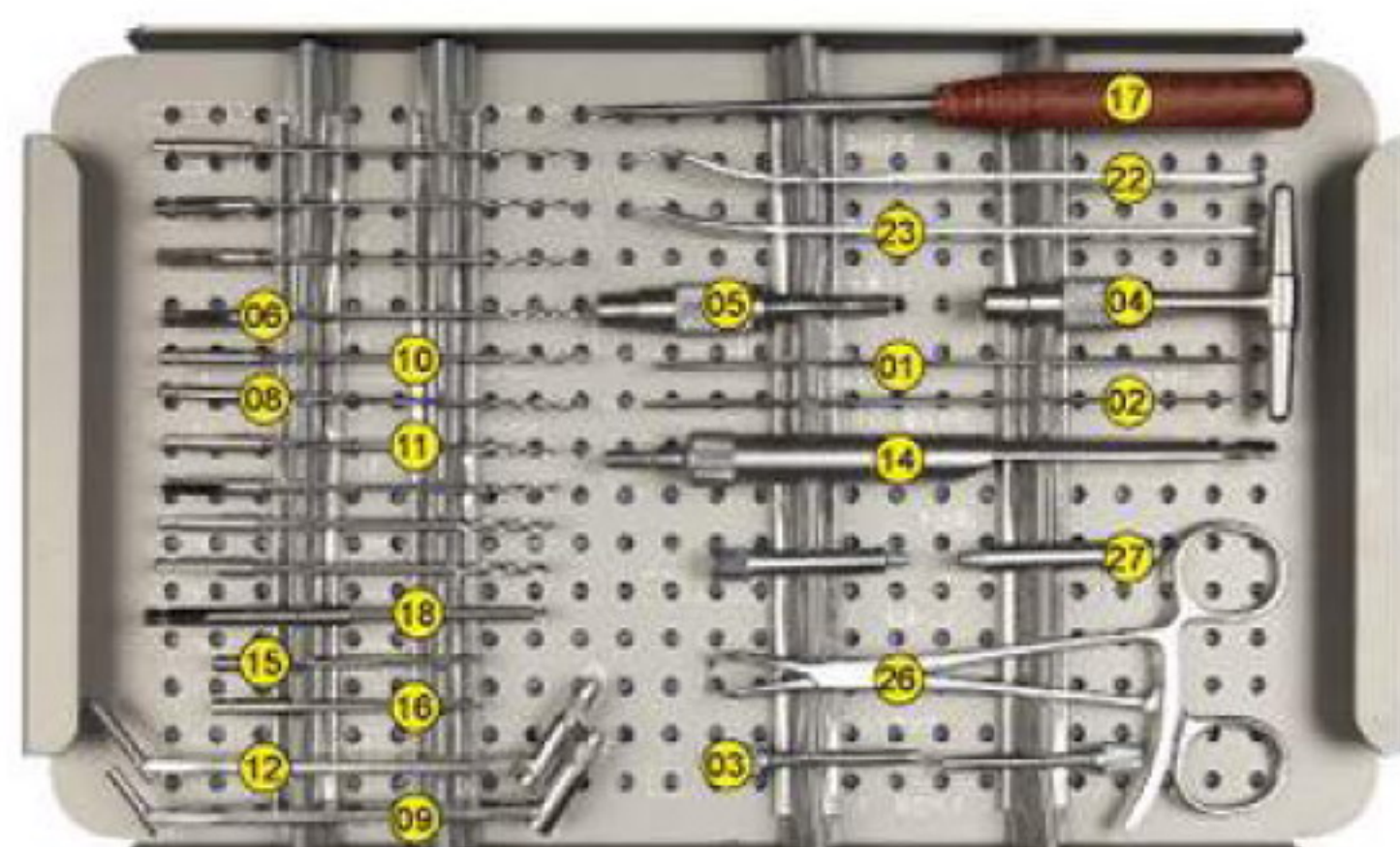

Product No.	Product Name	
T6230-0100	1.5*150	Guide Pin Φ1.5
T6230-0200	Φ 1.5*150	Threaded Guide PinΦ1.5
T6230-0300	1.5*51	Drill Sleeve Φ1.5
T6230-0400		T-handle, With Quick Coupling
T6230-0500		Quick Coupling Connector
T6230-0600	Φ 1.8*110	Drill BitΦ1.8
T6230-0700	Φ 1.8	Drill Sleeve Φ1.8
T6230-0800	Φ 2.5*102	Drill Bit Φ2.5
T6230-0900		Drill Guide
T6230-1000	Φ 2*102	Drill Bit Φ2
T6230-1100	Φ 2.7*102	Drill Bit Φ2.7
T6230-1200		Drill Guide
T6230-1300	Φ 2.5	Depth Gauge Φ2.5
T6230-1400	Φ 2.7	Depth Gauge Φ2.7
T6230-1500	HA2.5 P=1	Screw Tap HA2.5
T6230-1600	HA2.7 P=1	Screw Tap HA2.7
T6230-1700	2.5	Star Screwdriver 2.5
T6230-1800		Star Shaft 2.5
T6230-1900	Φ 3.5	Screw Holder Φ3.5
T6230-2000	Φ 5	Screw Holder Φ5.0
T6230-2100		Torque Screwdriver Limited
T6230-2200	6.5	Periosteum Elevator 6.5
T6230-2300	15.5	Periosteum Elevator 15.5
T6230-2400		Periosteal Elevator
T6230-2500		Periosteal Elevator
T6230-2600		Cusp Reduction Forceps (Small)
T6230-2700		Cusp Reduction Forceps
T6230-2800		Curved Reduction Forceps
T6230-2900		Plate Bender

4113 | DCP For Tibial Plate

4113-3/5004~4113-3/5014



4114 | LC-DCP Tibial Plate

4114-3/5004~4114-3/5014



4115 | DCP For Femur Plate

4115-3/5005~4115-3/5016



4116 | LC-DCP Femur Plate

4116-3/5005~4116-3/5015



Product No.		Holes	Plate Length*Width*Thickness
Pure Titanium	Stainless Steel		
4113-3004	4113-5004	4	80×13.5×4
4113-3005	4113-5005	5	96×13.5×4
4113-3006	4113-5006	6	112×13.5×4
4113-3007	4113-5007	7	128×13.5×4
4113-3008	4113-5008	8	144×13.5×4
4113-3009	4113-5009	9	160×13.5×4
4113-3010	4113-5010	10	176×13.5×4
4113-3011	4113-5011	11	192×13.5×4
4113-3012	4113-5012	12	208×13.5×4
4113-3013	4113-5013	13	224×13.5×4
4113-3014	4113-5014	14	240×13.5×4

Note:used for tibia with HA4.5 cortex screws

Product No.		Holes	Plate Length*Width*Thickness
Pure Titanium	Stainless Steel		
4114-3004	4114-5004	4	88×13.5×5
4114-3005	4114-5005	5	106×13.5×5
4114-3006	4114-5006	6	124×13.5×5
4114-3007	4114-5007	7	142×13.5×5
4114-3008	4114-5008	8	160×13.5×5
4114-3009	4114-5009	9	178×13.5×5
4114-3010	4114-5010	10	196×13.5×5
4114-3011	4114-5011	11	214×13.5×5
4114-3012	4114-5012	12	232×13.5×5
4114-3013	4114-5013	13	250×13.5×5
4114-3014	4114-5014	14	268×13.5×5

Note:used for tibia with HA4.5 cortex screws

Product No.		Holes	Plate Length*Width*Thickness
Pure Titanium	Stainless Steel		
4115-3005	4115-5005	5	96×17×5
4115-3006	4115-5006	6	112×17×5
4115-3007	4115-5007	7	128×17×5
4115-3008	4115-5008	8	144×17×5
4115-3009	4115-5009	9	160×17×5
4115-3010	4115-5010	10	176×17×5
4115-3011	4115-5011	11	192×17×5
4115-3012	4115-5012	12	208×17×5
4115-3013	4115-5013	13	224×17×5
4115-3014	4115-5014	14	240×17×5
4115-3015	4115-5015	15	256×17×5
4115-3016	4115-5016	16	272×17×5

Note:used for tibia with HA4.5 cortex screws

Product No.		Holes	Plate Length*Width*Thickness
Pure Titanium	Stainless Steel		
4116-3005	4116-5005	5	106×17×6
4116-3006	4116-5006	6	124×17×6
4116-3007	4116-5007	7	142×17×6
4116-3008	4116-5008	8	160×17×6
4116-3009	4116-5009	9	178×17×6
4116-3010	4116-5010	10	196×17×6
4116-3011	4116-5011	11	214×17×6
4116-3012	4116-5012	12	232×17×6
4116-3013	4116-5013	13	250×17×6
4116-3014	4116-5014	14	268×17×6
4116-3015	4116-5015	15	286×17×6

Note:used for tibia with HA4.5 cortex screws

LARGE BONE PLATE

4331 | Proximal Femur Locking Compression Plate

4331-3/5104~4331-3/5113



Product No.		Holes	Length
Pure Titanium	Stainless Steel		
4331-3104	4331-5104	4	122
4331-3105	4331-5105	5	140
4331-3106	4331-5106	6	158
4331-3107	4331-5107	7	176
4331-3108	4331-5108	8	194
4331-3109	4331-5109	9	212
4331-3110	4331-5110	10	230
4331-3111	4331-5111	11	248
4331-3112	4331-5112	12	266
4331-3113	4331-5113	13	284

Note: Select HB6.5 and HA4.5 screws

4338 | Proximal Femur Locking Compression Plate

4338-3/5104~4338-3/5211



Product No.		Holes	Length
Pure Titanium	Stainless Steel		
4338-3104	4338-5104	4 L	104
4338-3204	4338-5204	4 R	104
4338-3105	4338-5105	5 L	121
4338-3205	4338-5205	5 R	121
4338-3106	4338-5106	6 L	138
4338-3206	4338-5206	6 R	138
4338-3107	4338-5107	7 L	155
4338-3207	4338-5207	7 R	155
4338-3108	4338-5108	8 L	172
4338-3208	4338-5208	8 R	172
4338-3109	4338-5109	9 L	189
4338-3209	4338-5209	9 R	189
4338-3110	4338-5110	10 L	206
4338-3210	4338-5210	10 R	206
4338-3111	4338-5111	11 L	223
4338-3211	4338-5211	11 R	223

Note: Select HB6.5 and HA4.5 screws

4327 | Distal Femur Later Locking Compression Plate

4327-3/5105~4327-3/5213



Product No.		Holes	Length
Pure Titanium	Stainless Steel		
4327-3105	4327-5105	5 L	134
4327-3205	4327-5205	5 R	134
4327-3107	4327-5107	7 L	166
4327-3207	4327-5207	7 R	166
4327-3109	4327-5109	9 L	198
4327-3209	4327-5209	9 R	198
4327-3111	4327-5111	11 L	230
4327-3211	4327-5211	11 R	230
4327-3113	4327-5113	13 L	262
4327-3213	4327-5213	13 R	262

Note: Select HB6.5 and HA4.5 screws

4329 | Distal Femur Later Locking Compression Plate

4329-3/5105~4329-3/5213



Product No.		Holes	Length
Pure Titanium	Stainless Steel		
4329-3105	4329-5105	5 L	126
4329-3205	4329-5205	5 R	126
4329-3107	4329-5107	7 L	158
4329-3207	4329-5207	7 R	158
4329-3109	4329-5109	9 L	190
4329-3209	4329-5209	9 R	190
4329-3111	4329-5111	11 L	222
4329-3211	4329-5211	11 R	222
4329-3113	4329-5113	13 L	254
4329-3213	4329-5213	13 R	254

Note: Select HB6.5 and HA4.5 screws

LARGE BONE PLATE

4343 | Distal Femur Lateral Plate

4343-3/5105~4343-3/5213



Product No.		Holes	Length
Pure Titanium	Stainless Steel		
4343-3105	4343-5105	5 L	134
4343-3205	4343-5205	5 R	134
4343-3107	4343-5107	7 L	166
4343-3207	4343-5207	7 R	166
4343-3109	4343-5109	9 L	198
4343-3209	4343-5209	9 R	198
4343-3111	4343-5111	11 L	230
4343-3211	4343-5211	11 R	230
4343-3113	4343-5113	13 L	262
4343-3213	4343-5213	13 R	262

Note: Select HB6.5 and HA4.5 screws

4336 | Proximal Tibial Medial Plate

4336-3/5105~4336-3/5213



Product No.		Holes	Length
Pure Titanium	Stainless Steel		
4336-3105	4336-5105	5 L	126
4336-3205	4336-5205	5 R	126
4336-3107	4336-5107	7 L	158
4336-3207	4336-5207	7 R	158
4336-3109	4336-5109	9 L	190
4336-3209	4336-5209	9 R	190
4336-3111	4336-5111	11 L	222
4336-3211	4336-5211	11 R	222
4336-3113	4336-5113	13 L	254
4336-3213	4336-5213	13 R	254

Note: Select HB6.5 and HA4.5 screws

4325 | Proximal Tibial Lateral Plate

4325-3/5105~4325-3/5213



Product No.		Holes	Length
Pure Titanium	Stainless Steel		
4325-3105	4325-5105	5 L	126
4325-3205	4325-5205	5 R	126
4325-3107	4325-5107	7 L	158
4325-3207	4325-5207	7 R	158
4325-3109	4325-5109	9 L	190
4325-3209	4325-5209	9 R	190
4325-3111	4325-5111	11 L	222
4325-3211	4325-5211	11 R	222
4325-3113	4325-5113	13 L	254
4325-3213	4325-5213	13 R	254

Note: Select HB6.5 and HA4.5 screws

4341 | Proximal Tibial Lateral Plate

4341-3/5105~4341-3/5213



Product No.		Holes	Length
Pure Titanium	Stainless Steel		
4341-3105	4341-5105	5 L	126
4341-3205	4341-5205	5 R	126
4341-3107	4341-5107	7 L	158
4341-3207	4341-5207	7 R	158
4341-3109	4341-5109	9 L	190
4341-3209	4341-5209	9 R	190
4341-3111	4341-5111	11 L	222
4341-3211	4341-5211	11 R	222
4341-3113	4341-5113	13 L	254
4341-3213	4341-5213	13 R	254

Note: Select HB6.5 and HA4.5 screws

LARGE BONE PLATE

4323 |
Distal Tibial Medial Plate
4323-3/5005~4323-3/5013



Product No.		Holes	Length
Pure Titanium	Stainless Steel		
4323-3005	4323-5005	5	120
4323-3006	4323-5006	6	136
4323-3007	4323-5007	7	152
4323-3008	4323-5008	8	168
4323-3009	4323-5009	9	184
4323-3010	4323-5010	10	200
4323-3011	4323-5011	11	216
4323-3012	4323-5012	12	232
4323-3013	4323-5013	13	248

Note: Select HB6.5 and HA4.5 screws

4340 |
Distal Tibial Medial Plate
4340-3/5005~4340-3/5113



Product No.		Holes	Length
Pure Titanium	Stainless Steel		
4340-3005	4340-5005	5 L	114
4340-3105	4340-5105	5 R	114
4340-3007	4340-5007	7 L	146
4340-3107	4340-5107	7 R	146
4340-3009	4340-5009	9 L	168
4340-3109	4340-5109	9 R	168
4340-3011	4340-5011	11 L	200
4340-3111	4340-5111	11 R	200
4340-3013	4340-5013	13 L	230
4340-3113	4340-5113	13 R	230

Note: Select HB6.5 and HA4.5 screws

4324 |
Distal Tibial Lateral Plate
4324-3/5105~4324-3/5213



Product No.		Holes	Length
Pure Titanium	Stainless Steel		
4324-3105	4324-5105	5 L	121
4324-3205	4324-5205	5 R	121
4324-3107	4324-5107	7 L	157
4324-3207	4324-5207	7 R	157
4324-3109	4324-5109	9 L	193
4324-3209	4324-5209	9 R	193
4324-3111	4324-5111	11 L	229
4324-3211	4324-5211	11 R	229
4324-3113	4324-5113	13 L	265
4324-3213	4324-5213	13 R	265

Note: Select HB6.5 and HA4.5 screws

4344 |
Distal Tibial Lateral Plate
4344-3/5105~4344-3/5213



Product No.		Holes	Length
Pure Titanium	Stainless Steel		
4344-3105	4344-5105	5 L	105
4344-3205	4344-5205	5 R	105
4344-3106	4344-5106	6 L	121
4344-3206	4344-5206	6 R	121
4344-3107	4344-5107	7 L	137
4344-3207	4344-5207	7 R	137
4344-3108	4344-5108	8 L	153
4344-3208	4344-5208	8 R	153
4344-3109	4344-5109	9 L	169
4344-3209	4344-5209	9 R	169
4344-3110	4344-5110	10 L	185
4344-3210	4344-5210	10 R	185
4344-3111	4344-5111	11 L	201
4344-3211	4344-5211	11 R	201
4344-3112	4344-5112	12 L	217
4344-3212	4344-5212	12 R	217
4344-3113	4344-5113	13 L	233
4344-3213	4344-5213	13 R	233

Note: Select HB6.5 and HA4.5 screws

LARGE BONE PLATE

4214 | L- Plate
4214-3/5104~4214-3/5211



Product No.		Holes	Length
Pure Titanium	Stainless Steel		
4214-3105	4214-5105	5 L	96
4214-3205	4214-5205	5 R	96
4214-3106	4214-5106	6 L	112
4214-3206	4214-5206	6 R	112
4214-3107	4214-5107	7 L	128
4214-3207	4214-5207	7 R	128
4214-3108	4214-5108	8 L	144
4214-3208	4214-5208	8 R	144
4214-3109	4214-5109	9 L	160
4214-3209	4214-5209	9 R	160
4214-3110	4214-5110	10 L	176
4214-3210	4214-5210	10 R	176
4214-3111	4214-5111	11 L	192
4214-3211	4214-5211	11 R	192

Note: Select HB6.5 and HA4.5 screws

4215 | T- Plate
4215-3/5004~4215-3/5010



Product No.		Holes	Length
Pure Titanium	Stainless Steel		
4215-3004	4215-5004	4	80
4215-3005	4215-5005	5	96
4215-3006	4215-5006	6	112
4215-3007	4215-5007	7	120
4215-3008	4215-5008	8	144
4215-3009	4215-5009	9	160
4215-3010	4215-5010	10	176

Note: Select HB6.5 and HA4.5 screws

4216 | T-Buttress Plate
4216-3/5004~4216-3/5008



Product No.		Holes	Length
Pure Titanium	Stainless Steel		
4216-3004	4216-5004	4	80
4216-3005	4216-5005	5	96
4216-3006	4216-5006	6	112
4216-3007	4216-5007	7	128
4216-3008	4216-5008	8	144

Note: Select HB6.5 and HA4.5 screws

4218 | Reconstruction L- Plate
4218-3/5104~4218-3/5210



Product No.		Holes	Length
Pure Titanium	Stainless Steel		
4218-3104	4218-5104	4 L	84
4218-3204	4218-5204	4 R	84
4218-3105	4218-5105	5 L	100
4218-3205	4218-5205	5 R	100
4218-3106	4218-5106	6 L	116
4218-3206	4218-5206	6 R	116
4218-3107	4218-5107	7 L	132
4218-3207	4218-5207	7 R	132
4218-3108	4218-5108	8 L	148
4218-3208	4218-5208	8 R	148
4218-3109	4218-5109	9 L	164
4218-3209	4218-5209	9 R	164
4218-3110	4218-5110	10 L	180
4218-3210	4218-5210	10 R	180

Note: Select HB6.5 and HA4.5 screws

LARGE BONE PLATE

4219 | Reconstruction T- Plate

4219-3/5104~4219-3/5008



Product No.		Holes	Length
Pure Titanium	Stainless Steel		
4219-3004	4219-5004	4	84
4219-3005	4219-5005	5	100
4219-3006	4219-5006	6	116
4219-3007	4219-5007	7	132
4219-3008	4219-5008	8	148

Note: Select HB6.5 and HA4.5 screws

Tibial L- Plate

4220-3/5105~4220-3/5214



Product No.		Holes	Length
Pure Titanium	Stainless Steel		
4220-3105	4220-5105	5 L	85
4220-3205	4220-5205	5 R	85
4220-3106	4220-5106	6 L	99
4220-3206	4220-5206	6 R	99
4220-3107	4220-5107	7 L	113
4220-3207	4220-5207	7 R	113
4220-3108	4220-5108	8 L	127
4220-3208	4220-5208	8 R	127
4220-3109	4220-5109	9 L	141
4220-3209	4220-5209	9 R	141
4220-3110	4220-5110	10 L	155
4220-3210	4220-5210	10 R	155
4220-3111	4220-5111	11 L	169
4220-3211	4220-5211	11 R	169
4220-3112	4220-5112	12 L	183
4220-3212	4220-5212	12 R	183
4220-3113	4220-5113	13 L	197
4220-3213	4220-5213	13 R	197
4220-3114	4220-5114	14 L	211
4220-3214	4220-5214	14 R	211

Note: Select HA4.0 and HB4.0 screws

4333 | Distal Fibula Plate

4333-3/5104~4333-3/5208



Product No.		Holes	Length
Pure Titanium	Stainless Steel		
4333-3104	4333-5104	4 L	62
4333-3204	4333-5204	4 R	62
4333-3105	4333-5105	5 L	74
4333-3205	4333-5205	5 R	74
4333-3106	4333-5106	6 L	86
4333-3206	4333-5206	6 R	86
4333-3107	4333-5107	7 L	98
4333-3207	4333-5207	7 R	98
4333-3108	4333-5108	8 L	110
4333-3208	4333-5208	8 R	110

Note: Select HA3.5 and HB3.5 screws

4317 | Distal Fibula Plate

4317-3/5003~4317-3/5008



Product No.		Holes	Length
Pure Titanium	Stainless Steel		
4317-3003	4317-5003	3	72
4317-3004	4317-5004	4	84
4317-3005	4317-5005	5	96
4317-3006	4317-5006	6	108
4317-3007	4317-5007	7	120
4317-3008	4317-5008	8	132

Note: Select HA3.5 and HB3.5 screws

LARGE BONE PLATE

4353 | Distal Fibula Plate

4353-3/5103~4353-3/5208



Product No.		Holes	Length
Pure Titanium	Stainless Steel		
4353-3103	4353-5103	3 L	64
4353-3203	4353-5203	3 R	64
4353-3104	4353-5104	4 L	74
4353-3204	4353-5204	4 R	74
4353-3105	4353-5105	5 L	84
4353-3205	4353-5205	5 R	84
4353-3106	4353-5106	6 L	94
4353-3206	4353-5206	6 R	94
4353-3107	4353-5107	7 L	104
4353-3207	4353-5207	7 R	104
4353-3108	4353-5108	8 L	114
4353-3208	4353-5208	8 R	114

Note: Select HA3.5 and HB3.5 screws

4334 | Calcaneal Plate

4334-3/5100~4334-3/5200



Product No.		Specifications	Length
Pure Titanium	Stainless Steel		
4334-3100	4334-5100	Large	73
4334-3200	4334-5200	Small	58

Note: Select HA4 screws

4335 | Calcaneal Plate

4335-3/5103~4335-3/5204



Product No.		Specifications	Length
Pure Titanium	Stainless Steel		
4335-3103	4335-5103	Long, 3 holes	80
4335-3104	4335-5104	Long, 4 holes	89
4335-3203	4335-5203	Short, 3 holes	60
4335-3204	4335-5204	Short, 4 holes	69

Note: Select HA4 screws

4217 | Curved Pelvis Plate

4217-3/5004~4217-3/5012



Product No.		Holes	Length
Pure Titanium	Stainless Steel		
4217-3004	4217-5004	4	53
4217-3005	4217-5005	5	66
4217-3006	4217-5006	6	79
4217-3007	4217-5007	7	91
4217-3008	4217-5008	8	102
4217-3009	4217-5009	9	113
4217-3010	4217-5010	10	123
4217-3011	4217-5011	11	132
4217-3012	4217-5012	12	141

Note: Select HA4 screws

4241 | Patella Claw

4241-3/5010~4241-3/5030



Product No.		Specifications
Pure Titanium	Stainless Steel	
4241-3010	4241-5010	Large
4241-3020	4241-5020	Medium
4241-3030	4241-5030	Small
4241-3040	4241-5040	Extra Small

LARGE BONE PLATE

T4113
Large Bone Fracture Instrument Case (Large)

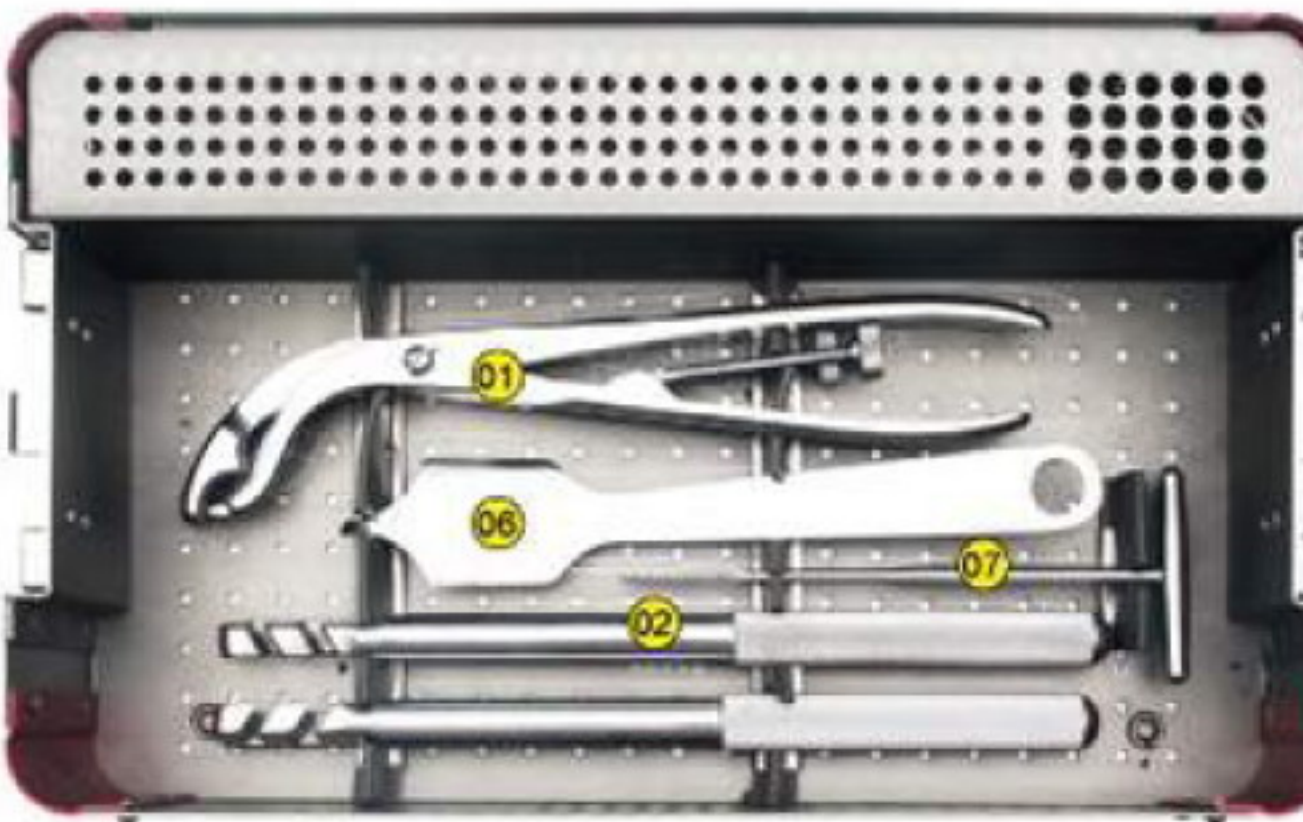
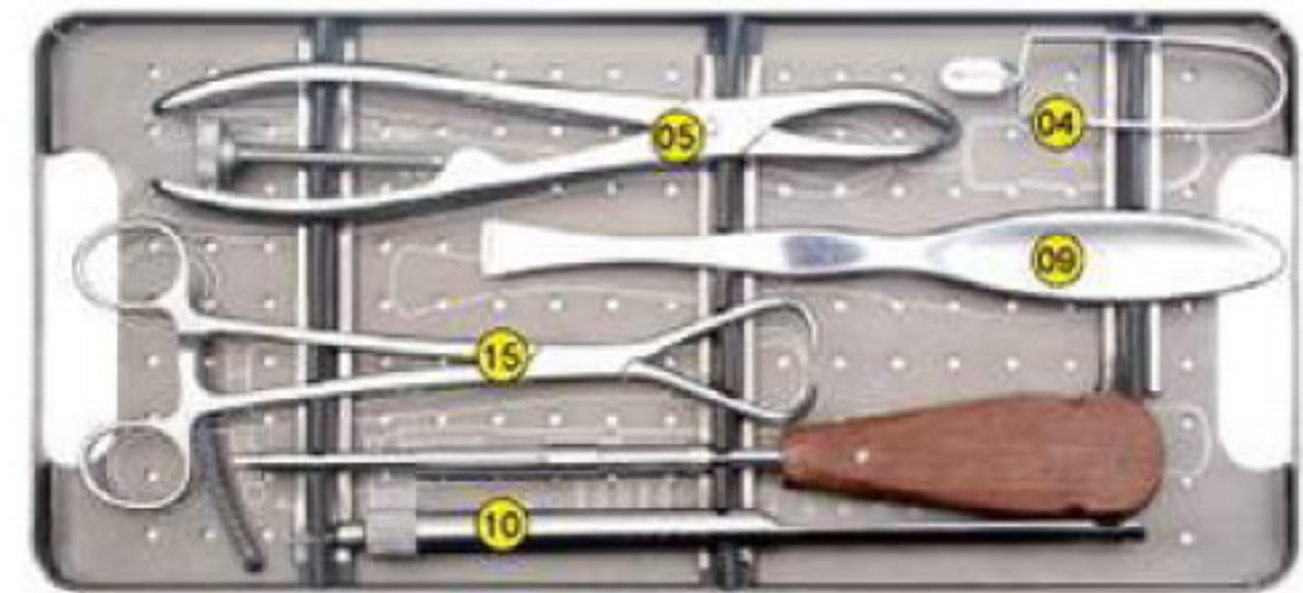
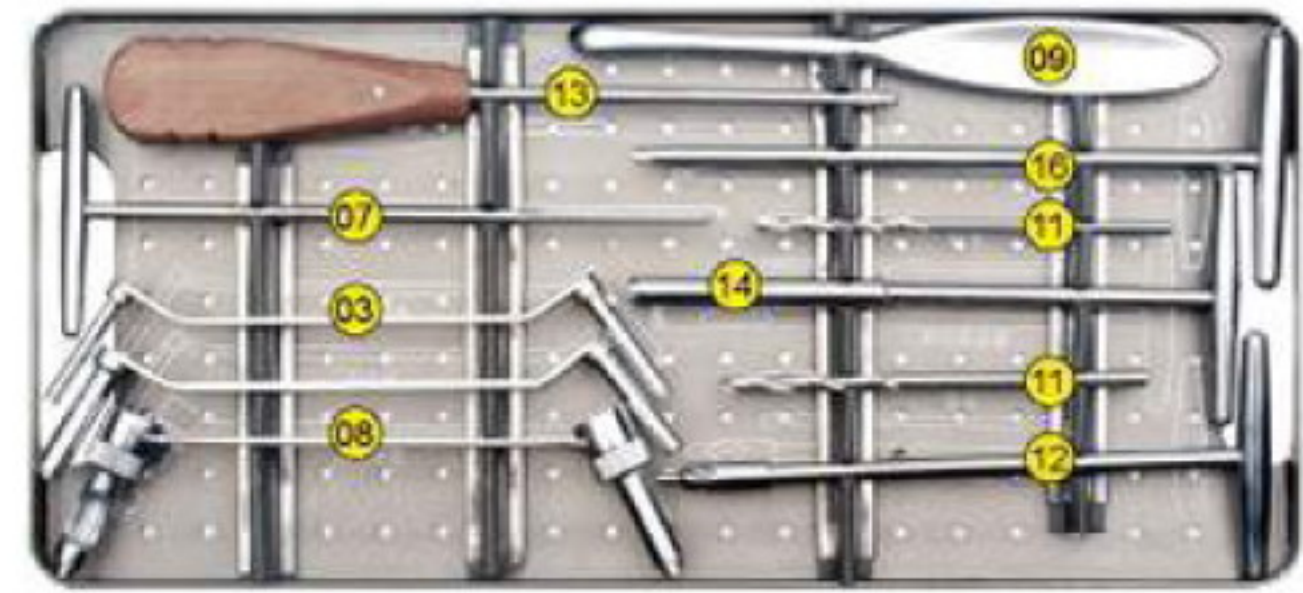

Product No.	Product Name	
T4113-0100		Self-Centering Forcep
T4113-0200		Plate Bending Wrench
T4113-0300		Drill Guide
T4113-0301		Tap Guide
T4113-0400		Screw Holder
T4113-0500		Bone Holding Forcep (Large)
T4113-0600		Retractor(Large)
T4113-0601		Retractor(Small)
T4113-0700	HA4.5	Screw Tap HA4.5
T4113-0701		Screw Tap HB6.5
T4113-0800		Double Head Drill Guide
T4113-0900		Periosteal Elevator
T4113-1000		Depth Gauge
T4113-1100		Drill BitΦ3.2
T4113-1101	Φ4.5	Drill BitΦ4.5
T4113-1200		Countersink Drill
T4113-1300		Protected Screw Extractor
T4113-1400		Broken Screw Extractor
T4113-1500		Cusp Reduction Forceps (Large)
T4113-1600		Screw Driver(Hex)SW3.5
T4113-1700		Protected Screw Driver(Hex)

T4114
Large Bone Fracture Instrument Case (Small)

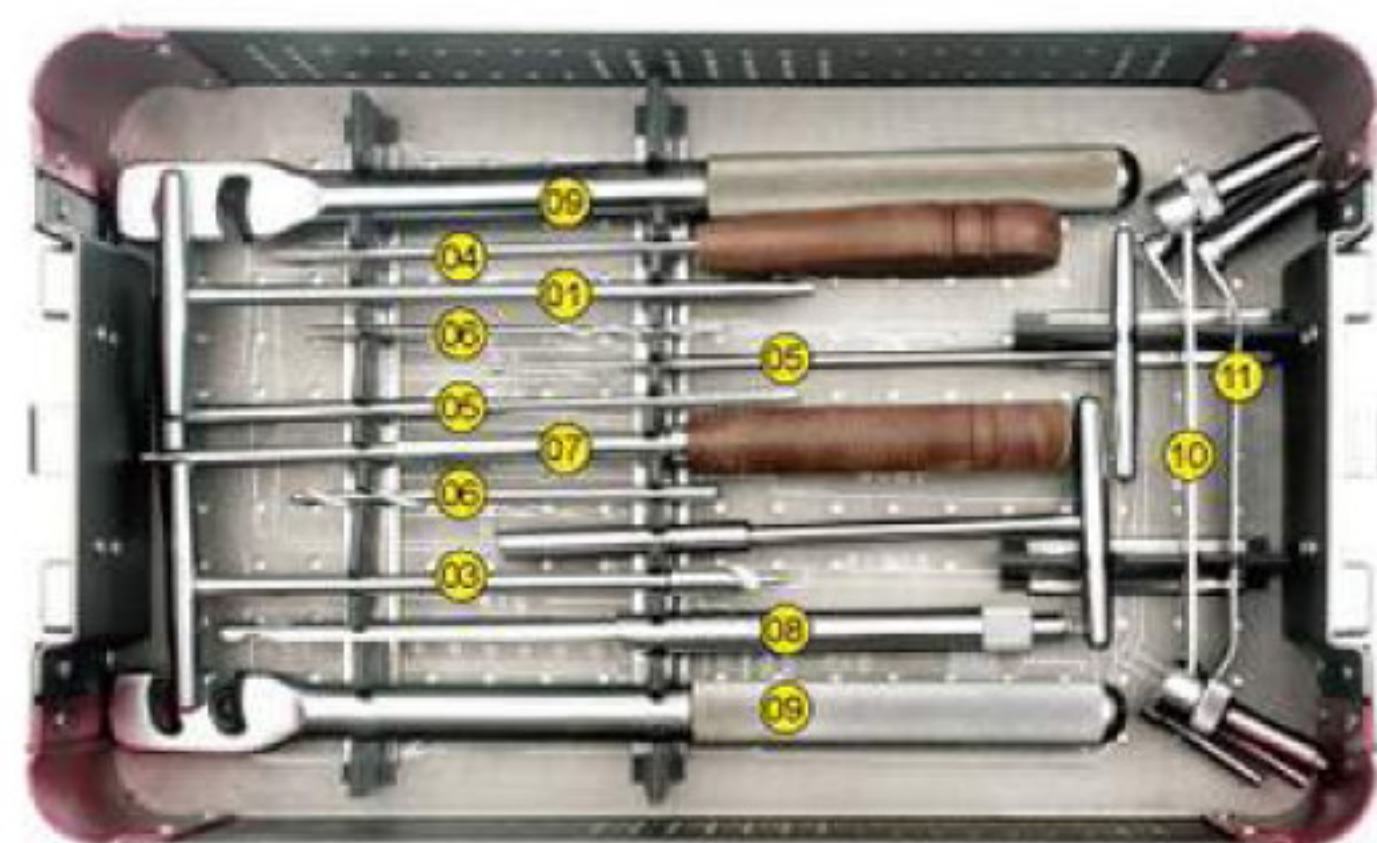

Product No.	Product Name	
T4114-0100	SW3.5	Screw Driver (Hex) SW3.5
T4114-0200		Broken Screw Extractor
T4114-0300		Countersink Drill
T4114-0400		Screw Anti-skidding Extractor
T4114-0500	HA4.5	Screw Tap HA4.5
T4114-0501		Screw Tap HB6.5
T4114-0600	Φ3.2	Drill Bit Φ3.2
T4114-0601		Drill Bit Φ4.5
T4114-0700	SW3.5	Protected Screw Driver SW3.5
T4114-0800		Depth Gauge
T4114-0900		Plate Bending Wrench
T4114-1000		Double Head Drill Guide
T4114-1100		Drill Sleeve

LARGE BONE PLATE

T4200
Large Bone Fracture Instrument Case

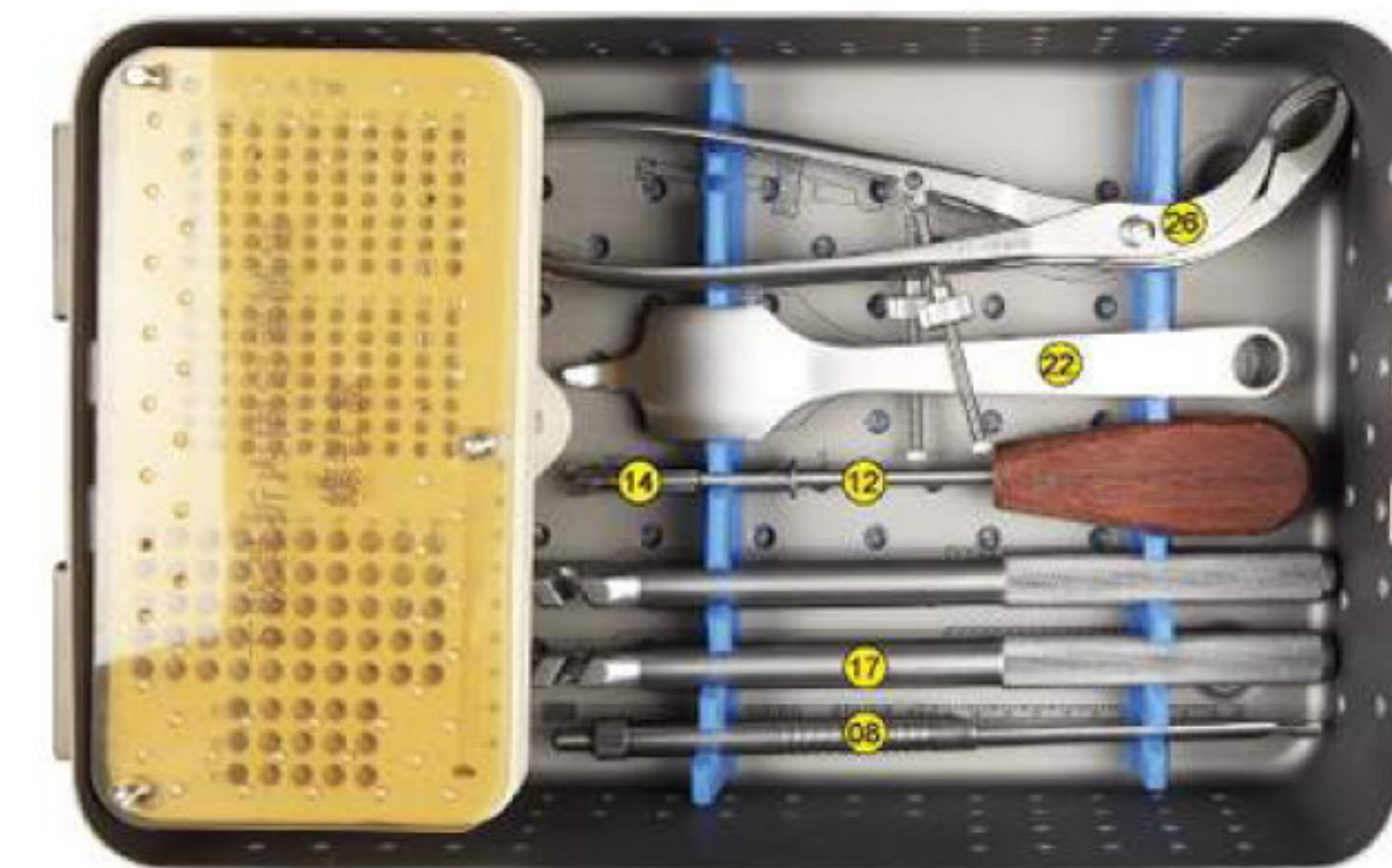
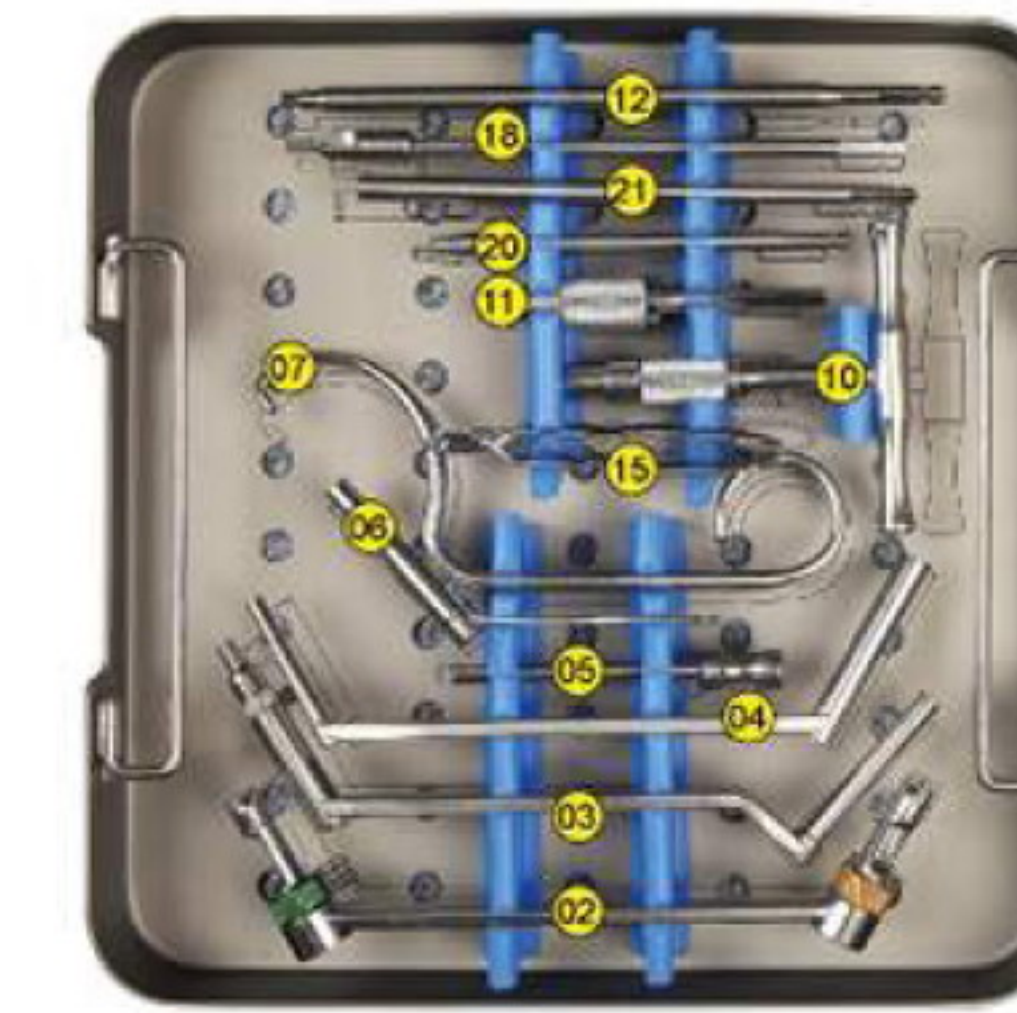
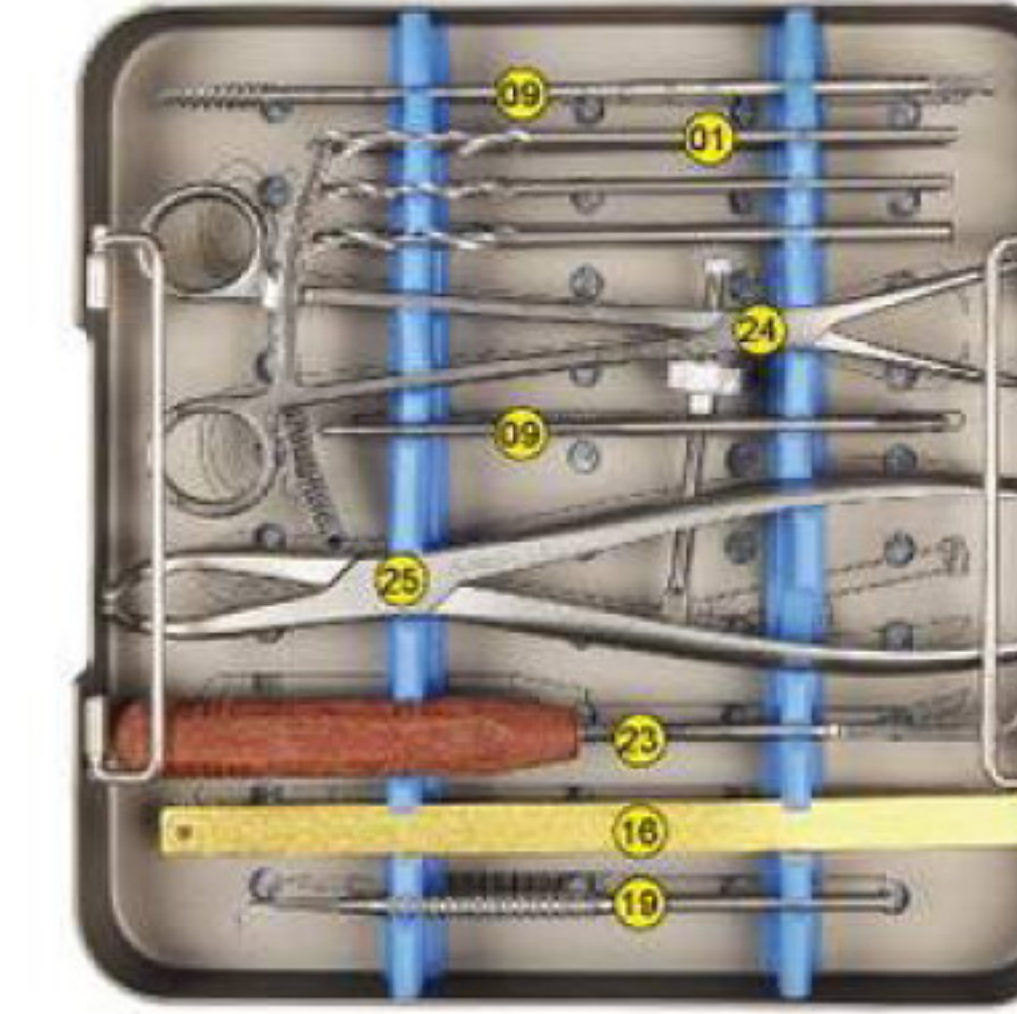

Product No.	Product Name	
T4200-0100	Φ3.2 L=150	Drill Bit Φ3.2
T4200-0101	Φ4.5 L=150	Drill Bit Φ4.5
T4200-0200	DCP Φ3.2	DCP Drill Guide
T4200-0300	Φ3.2/Φ4.5	Drill Guide Φ3.2/Φ4.5(Self-centering)
T4200-0400	Φ3.2/Φ6.5	Drill Guide Φ3.2/Φ6.5
T4200-0500	Φ3.2 L=80	Drill Sleeve Φ3.2
T4200-0800	4.5mm Φ2.7	Depth Gauge
T4200-0900	Φ4.5 HA4.5	Screw Tap HA4.5
T4200-1000		Quick Coupling (T-handle)
T4200-1100		Quick Coupling Connector
T4200-1200	SW3.5 (L=160) Φ6	Hex Screwdriver
T4200-1201	SW3.5 Φ6	Hex Screwdriver
T4200-1400	Φ6 Φ8	Screw Holding Sleeve
T4200-1500	R1.6	Screw Holder
T4200-1700		Bending Wrench(Left)
T4200-1701		Bending Wrench(Right)
T4200-1800	Φ3/Φ8	Countersink Drill
T4200-1900		Sharp Hook
T4200-2000	SW3.5	Screw Anti-skidding Extractor
T4200-2100	Φ4.5	Broken Screw Extractor
T4200-2200	16	Periosteum Retractor 16
T4200-2201	44	Periosteum Retractor 14
T4200-2300		Periosteal Detacher
T4200-2400		Cusp Reduction Forceps
T4200-2500		Curved Reduction Forceps
T4200-2600		Centering Forceps

LARGE BONE PLATE

T4119
Reconstruction Plate Instrument Case

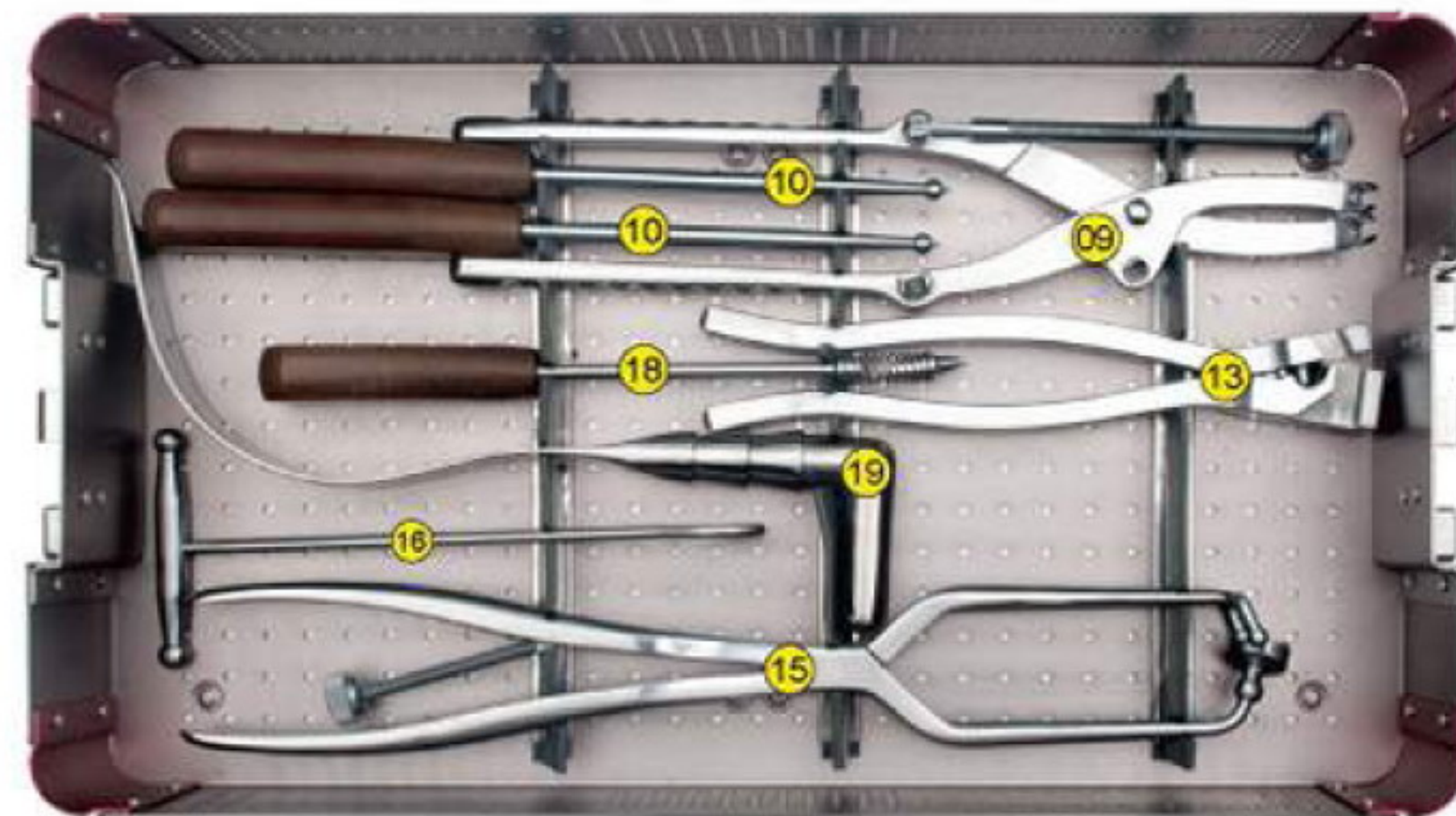
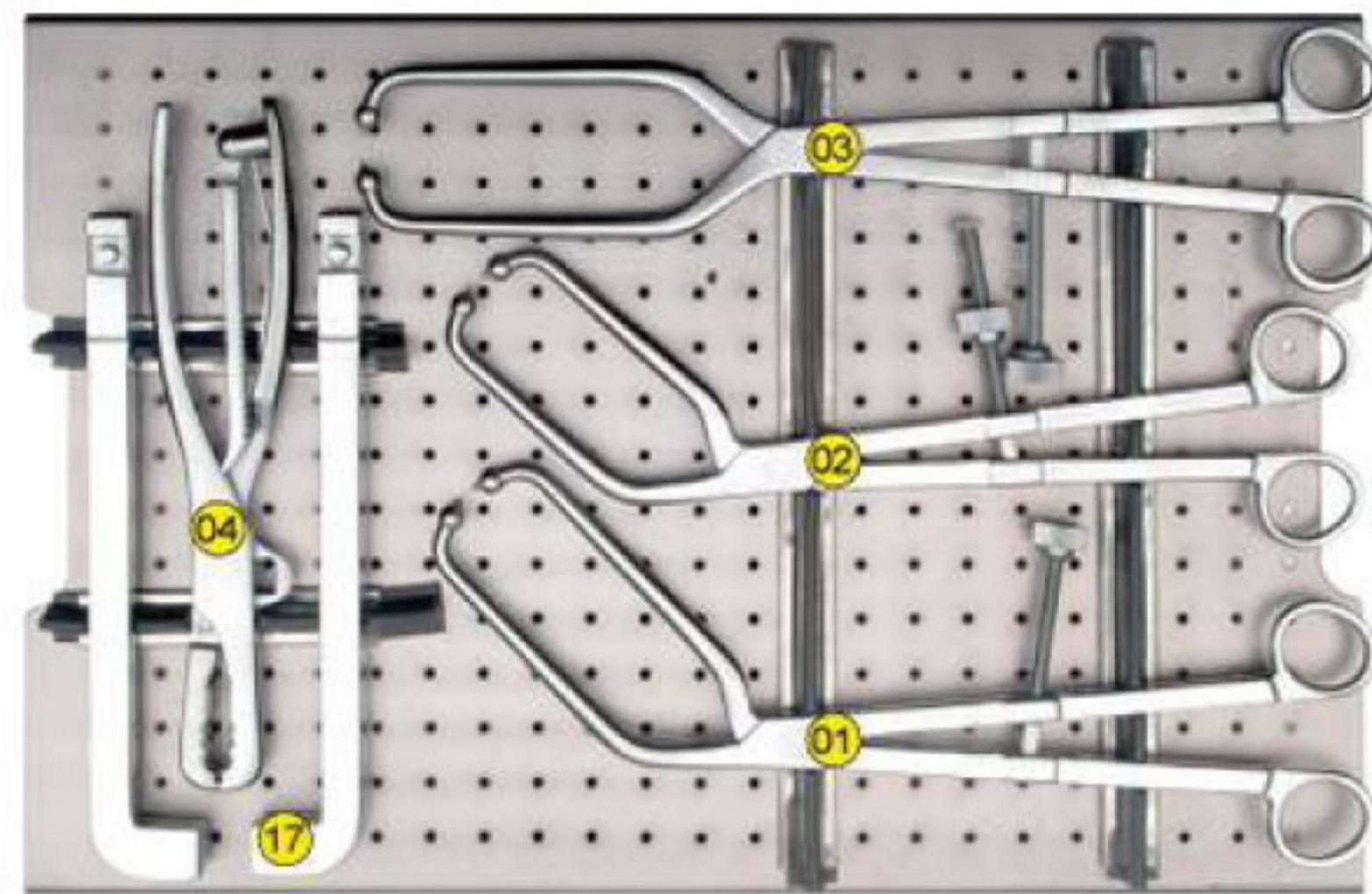
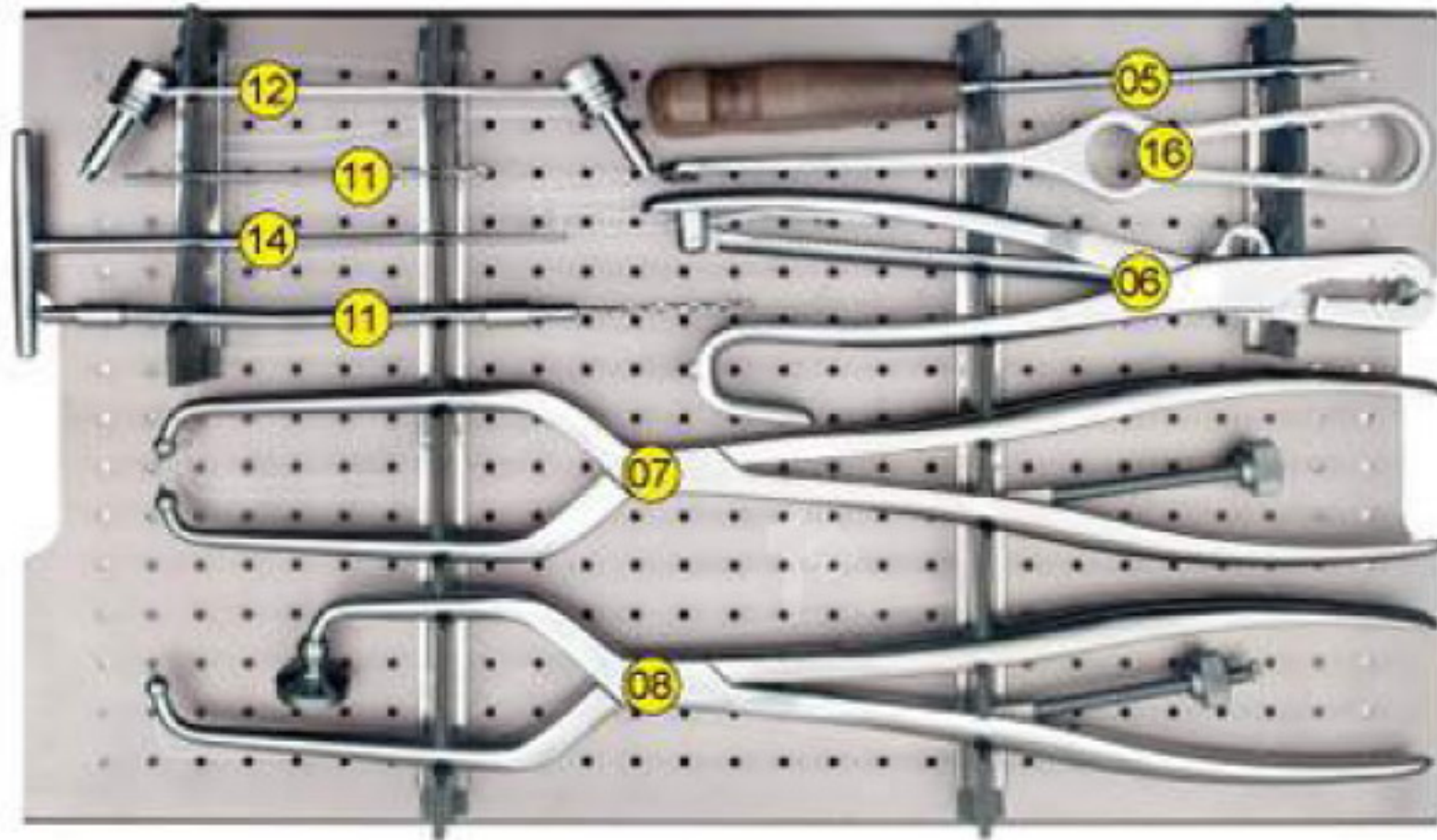

Product No.	Product Name
T4119-0100	Reduction Forceps,Oblique,1#
T4119-0200	Reduction Forceps,Oblique,2#
T4119-0300	Pelvic Reduction Forceps with points
T4119-0400	Bone Holding Forcep (Small)
T4119-0500	SW2.5 Screw Driver(Hex)SW2.5
T4119-0600	Bone Holding Forcep (Large)
T4119-0700	Pelvic Reduction Forceps,1#
T4119-0800	Pelvic Reduction Forceps,2#
T4119-0900	Acetabulum Reduction Forceps
T4119-1000	Loeating driver
T4119-1100	Drill BitΦ2.5
T4119-1200	Combination Drill Guide
T4119-1300	Plate Bending Wrench
T4119-1400	Screw Tap HA3.5
T4119-1500	Reduction Forceps With 3Ball Tips
T4119-1600	Sharp Hook
T4119-1601	T-Sharp Hook
T4119-1700	Plate Bonding Wrench
T4119-1800	Universal Screw Driver
T4119-1900	Hohmann Retractor
T4119-2000	Drill Guide Sleeve

LARGE BONE LOCKING COMPRESSION PLATE(COMBINATION HOLE)

6127 |
LC-DCP Tibial Locking Compression Plate
6127-3/5005~6127-3/5015



6128 |
LC-DCP Femur Locking Compression Plate
6128-3/5006~6128-3/5016



6367 |
Proximal Femur Locking Compression Plate
6367-3/5105~6367-3/5213



6162 |
Metaphyseal Plate
6162-3/5003 ~ 6162-3/5015



6150 |
Reconstructio locking compression plate
6150-3/5005 ~ 6150-3/5016



Product No.		Holes	Length
Pure Titanium	Stainless Steel		
6150-3005	6150-5005	5	89
6150-3006	6150-5006	6	107
6150-3007	6150-5007	7	125
6150-3008	6150-5008	8	143
6150-3009	6150-5009	9	161
6150-3010	6150-5010	10	179
6150-3011	6150-5011	11	197
6150-3012	6150-5012	12	215
6150-3013	6150-5013	13	233
6150-3014	6150-5014	14	251
6150-3015	6150-5015	15	269
6150-3016	6150-5016	16	287

Note:Select HC5.0 and HA4.5 screws

Product No.		Holes	Length
Pure Titanium	Stainless Steel		
6127-3005	6127-5005	5	95
6127-3006	6127-5006	6	113
6127-3007	6127-5007	7	131
6127-3008	6127-5008	8	149
6127-3009	6127-5009	9	167
6127-3010	6127-5010	10	185
6127-3011	6127-5011	11	203
6127-3012	6127-5012	12	221
6127-3013	6127-5013	13	239
6127-3014	6127-5014	14	257
6127-3015	6127-5015	15	275

Note:Select HC5.0 and HA4.5 screws

Product No.		Holes	Length
Pure Titanium	Stainless Steel		
6128-3006	6128-5006	6	117
6128-3007	6128-5007	7	135
6128-3008	6128-5008	8	153
6128-3009	6128-5009	9	171
6128-3010	6128-5010	10	189
6128-3011	6128-5011	11	207
6128-3012	6128-5012	12	225
6128-3013	6128-5013	13	243
6128-3014	6128-5014	14	261
6128-3015	6128-5015	15	279
6128-3016	6128-5016	16	297

Note:Select HC5.0 and HA4.5 screws

Product No.		Holes	Length
Pure Titanium	Stainless Steel		
6367-3105	6367-5105	5 L	162
6367-3205	6367-5205	5 R	162
6367-3106	6367-5106	6 L	180
6367-3206	6367-5206	6 R	180
6367-3107	6367-5107	7 L	198
6367-3207	6367-5207	7 R	198
6367-3108	6367-5108	8 L	216
6367-3208	6367-5208	8 R	216
6367-3109	6367-5109	9 L	234
6367-3209	6367-5209	9 R	234
6367-3110	6367-5110	10 L	252
6367-3210	6367-5210	10 R	252
6367-3111	6367-5111	11 L	270
6367-3211	6367-5211	11 R	270
6367-3112	6367-5112	12 L	288
6367-3212	6367-5212	12 R	288
6367-3113	6367-5113	13 L	306
6367-3213	6367-5213	13 R	306

Note:Select HC5.0, HB6.5 and HA4.5 screws

Product No.		Holes	Length
Pure Titanium	Stainless Steel		
6162-3003	6162-5003	3	118
6162-3004	6162-5004	4	136
6162-3005	6162-5005	5	154
6162-3006	6162-5006	6	172
6162-3007	6162-5007	7	190
6162-3008	6162-5008	8	209
6162-3009	6162-5009	9	226
6162-3011	6162-5011	10	262
6162-3013	6162-5013	11	298
6162-3015	6162-5015	12	334

Note:Select HC5.0 and HA4.5 screws

6366 |
Proximal Femur Locking Compression Plate
6366-3/5005-6366-3/5014



Product No.		Holes	Length
Pure Titanium	Stainless Steel		
6366-3005	6366-5005	5	125
6366-3006	6366-5006	6	141
6366-3007	6366-5007	7	157
6366-3008	6366-5008	8	173
6366-3009	6366-5009	9	189
6366-3010	6366-5010	10	205
6366-3011	6366-5011	11	221
6366-3012	6366-5012	12	237
6366-3013	6366-5013	13	253
6366-3014	6366-5014	14	269
6366-3015	6366-5015	15	285

Note: Select HB6.5, HC6.5, HC5.0 and HA4.5 screws

6383 |
Proximal Femur Locking Compression Plate
6383-3/5005-6383-3/5014



Product No.		Holes	Length
Pure Titanium	Stainless Steel		
6383-3005	6383-5005	5	125
6383-3006	6383-5006	6	141
6383-3007	6383-5007	7	157
6383-3008	6383-5008	8	173
6383-3009	6383-5009	9	189
6383-3010	6383-5010	10	205
6383-3011	6383-5011	11	221
6383-3012	6383-5012	12	237
6383-3013	6383-5013	13	253
6383-3014	6383-5014	14	269
6383-3015	6383-5015	15	285

Note: Select HB6.5, HC6.5, HC5.0 and HA4.5 screws

6363 |
Proximal Femur Locking Compression Plate
6363-3/5104-6363-3/5211



Product No.		Holes	Length
Pure Titanium	Stainless Steel		
6363-3104	6363-5104	4 L	120
6363-3204	6363-5204	4 R	120
6363-3105	6363-5105	5 L	138
6363-3205	6363-5205	5 R	138
6363-3106	6363-5106	6 L	156
6363-3206	6363-5206	6 R	156
6363-3107	6363-5107	7 L	174
6363-3207	6363-5207	7 R	174
6363-3108	6363-5108	8 L	192
6363-3208	6363-5208	8 R	192
6363-3109	6363-5109	9 L	209
6363-3209	6363-5209	9 R	209
6363-3110	6363-5110	10 L	227
6363-3210	6363-5210	10 R	227
6363-3111	6363-5111	11 L	245
6363-3211	6363-5211	11 R	245

Note: Select HC6.5, HC5.0 and HA4.5 screws

6381 |
Proximal Femur Locking Compression Plate
6381-3/5104-6381-3/5211



Product No.		Holes	Length
Pure Titanium	Stainless Steel		
6381-3104	6381-5104	4 L	120
6381-3204	6381-5204	4 R	120
6381-3105	6381-5105	5 L	138
6381-3205	6381-5205	5 R	138
6381-3106	6381-5106	6 L	156
6381-3206	6381-5206	6 R	156
6381-3107	6381-5107	7 L	174
6381-3207	6381-5207	7 R	174
6381-3108	6381-5108	8 L	192
6381-3208	6381-5208	8 R	192
6381-3109	6381-5109	9 L	209
6381-3209	6381-5209	9 R	209
6381-3110	6381-5110	10 L	227
6381-3210	6381-5210	10 R	227
6381-3111	6381-5111	11 L	245
6381-3211	6381-5211	11 R	245

Note: Select HC6.5, HC5.0 and HA4.5 screws

6361 |
Proximal Femur Locking Compression Plate
6361-3/5105-6361-3/5212



Product No.		Holes	Length
Pure Titanium	Stainless Steel		
6361-3105	6361-5105	5 L	177
6361-3205	6361-5205	5 R	177
6361-3106	6361-5106	6 L	197
6361-3206	6361-5206	6 R	197
6361-3107	6361-5107	7 L	217
6361-3207	6361-5207	7 R	217
6361-3108	6361-5108	8 L	237
6361-3208	6361-5208	8 R	237
6361-3109	6361-5109	9 L	256
6361-3209	6361-5209	9 R	256
6361-3110	6361-5110	10 L	276
6361-3210	6361-5210	10 R	276
6361-3111	6361-5111	11 L	296
6361-3211	6361-5211	11 R	296
6361-3112	6361-5112	12 L	316
6361-3212	6361-5212	12 R	316

Note: Select HC5.0 and HA4.5 screws

6360 |
Distal Femoral Lateral Locking Compression Plate
6360-3/5105-6360-3/5213



Product No.		Holes	Length
Pure Titanium	Stainless Steel		
6360-3105	6360-5105	5 L	157
6360-3205	6360-5205	5 R	157
6360-3106	6360-5106	6 L	177
6360-3206	6360-5206	6 R	177
6360-3107	6360-5107	7 L	197
6360-3207	6360-5207	7 R	197
6360-3108	6360-5108	8 L	217
6360-3208	6360-5208	8 R	217
6360-3109	6360-5109	9 L	237
6360-3209	6360-5209	9 R	237
6360-3110	6360-5110	10 L	257
6360-3210	6360-5210	10 R	257
6360-3111	6360-5111	11 L	277
6360-3211	6360-5211	11 R	277
6360-3112	6360-5112	12 L	297
6360-3212	6360-5212	12 R	297
6360-3113	6360-5113	13 L	317
6360-3213	6360-5213	13 R	317

Note: Select HC5.0 and HA4.5 screws

6365 |
Proximal Tibial Lateral Locking Compression Plate
6165-3/5104-6165-3/5215



Product No.		Holes	Length
Pure Titanium	Stainless Steel		
6365-3104	6365-5104	4 L	84
6365-3204	6365-5204	4 R	84
6365-3105	6365-5105	5 L	102
6365-3205	6365-5205	5 R	102
6365-3106	6365-5106	6 L	120
6365-3206	6365-5206	6 R	120
6365-3107	6365-5107	7 L	138
6365-3207	6365-5207	7 R	138
6365-3108	6365-5108	8 L	156
6365-3208	6365-5208	8 R	156
6365-3109	6365-5109	9 L	174
6365-3209	6365-5209	9 R	174
6365-3110	6365-5110	10 L	192
6365-3210	6365-5210	10 R	192
6365-3111	6365-5111	11 L	210
6365-3211	6365-5211	11 R	210
6365-3112	6365-5112	12 L	228
6365-3212	6365-5212	12 R	228
6365-3113	6365-5113	13 L	246
6365-3213	6365-5213	13 R	246
6365-3114	6365-5114	14 L	264
6365-3214	6365-5214	14 R	264
6365-3115	6365-5115	15 L	282
6365-3215	6365-5215	15 R	282

Note: Select HC5.0, HB6.5 and HA4.5 screws

6359 |
Proximal Tibial Lateral Locking Compression Plate
6359-3/5105~6359-3/5213



Product No.		Holes	Length
Pure Titanium	Stainless Steel		
6359-3105	6359-5105	5 L	145
6359-3205	6359-5205	5 R	145
6359-3106	6359-5106	6 L	163
6359-3206	6359-5206	6 R	163
6359-3107	6359-5107	7 L	181
6359-3207	6359-5207	7 R	181
6359-3108	6359-5108	8 L	199
6359-3208	6359-5208	8 R	199
6359-3109	6359-5109	9 L	217
6359-3209	6359-5209	9 R	217
6359-3110	6359-5110	10 L	235
6359-3210	6359-5210	10 R	235
6359-3111	6359-5111	11 L	253
6359-3211	6359-5211	11 R	253
6359-3112	6359-5112	12 L	271
6359-3212	6359-5212	12 R	271
6359-3113	6359-5113	13 L	289
6359-3213	6359-5213	13 R	289

Note: Select HC5.0 and HA4.5 screws

6362 |
Distal Tibial Media Locking Compression Plate
6362-3/5105~6362-3/5212



Product No.		Holes	Length
Pure Titanium	Stainless Steel		
6362-3105	6362-5105	5 L	132
6362-3205	6362-5205	5 R	132
6362-3106	6362-5106	6 L	145
6362-3206	6362-5206	6 R	145
6362-3107	6362-5107	7 L	158
6362-3207	6362-5207	7 R	158
6362-3108	6362-5108	8 L	171
6362-3208	6362-5208	8 R	171
6362-3109	6362-5109	9 L	184
6362-3209	6362-5209	9 R	184
6362-3110	6362-5110	10 L	197
6362-3210	6362-5210	10 R	197
6362-3111	6362-5111	11 L	210
6362-3211	6362-5211	11 R	210
6362-3112	6362-5112	12 L	233
6362-3212	6362-5212	12 R	233

Note: Select HC3.5 and HA3.5 screws

6247 |
Distal Tibial Lateral Locking Compression Plate
6247-3/5106~6247-3/5215



Product No.		Holes	Length
Pure Titanium	Stainless Steel		
6247-3106	6247-5106	6 L	92
6247-3206	6247-5206	6 R	92
6247-3107	6247-5107	7 L	105
6247-3207	6247-5207	7 R	105
6247-3108	6247-5108	8 L	118
6247-3208	6247-5208	8 R	118
6247-3109	6247-5109	9 L	131
6247-3209	6247-5209	9 R	131
6247-3110	6247-5110	10 L	144
6247-3210	6247-5210	10 R	144
6247-3111	6247-5111	11 L	157
6247-3211	6247-5211	11 R	157
6247-3112	6247-5112	12 L	170
6247-3212	6247-5212	12 R	170
6247-3113	6247-5113	13 L	183
6247-3213	6247-5213	13 R	183
6247-3114	6247-5114	14 L	196
6247-3214	6247-5214	14 R	196
6247-3115	6247-5115	15 L	209
6247-3215	6247-5215	15 R	209

Note: Select HC3.5 and HA3.5 screws

6244 |
L-Locking Plate
6244-3/5104 ~ 62442-3/5214



Product No.		Holes	Length
Pure Titanium	Stainless Steel		
6244-3104	6244-5104	4 L	76
6244-3204	6244-5204	4 R	76
6244-3105	6244-5105	5 L	90
6244-3205	6244-5205	5 R	90
6244-3106	6244-5106	6 L	104
6244-3206	6244-5206	6 R	104
6244-3107	6244-5107	7 L	117
6244-3207	6244-5207	7 R	117
6244-3108	6244-5108	8 L	131
6244-3208	6244-5208	8 R	131
6244-3109	6244-5109	9 L	145
6244-3209	6244-5209	9 R	145
6244-3110	6244-5110	10 L	160
6244-3210	6244-5210	10 R	160
6244-3111	6244-5111	11 L	174
6244-3211	6244-5211	11 R	174
6244-3112	6244-5112	12 L	188
6244-3212	6244-5212	12 R	188
6244-3113	6244-5113	13 L	202
6244-3213	6244-5213	13 R	202
6244-3114	6244-5114	14 L	216
6244-3214	6244-5214	14 R	216

Note: Select HC3.5 and HA3.5 screws

6323 |
Distal Tibial Medial Locking Compression Plate
6323-3/5003 ~ 6323-3/5013



Product No.		Holes	Length
Pure Titanium	Stainless Steel		
6323-3005	6323-5005	5	128
6323-3006	6323-5006	6	146
6323-3007	6323-5007	7	164
6323-3008	6323-5008	8	182
6323-3009	6323-5009	9	200
6323-3010	6323-5010	10	218
6323-3011	6323-5011	11	236
6323-3012	6323-5012	12	254
6323-3013	6323-5013	13	272

Note: Select HC5.0 and HA4.5 screws

6388 |
Distal Tibial Medial Locking Plate
6388-3/5006 ~ 6388-3/5008

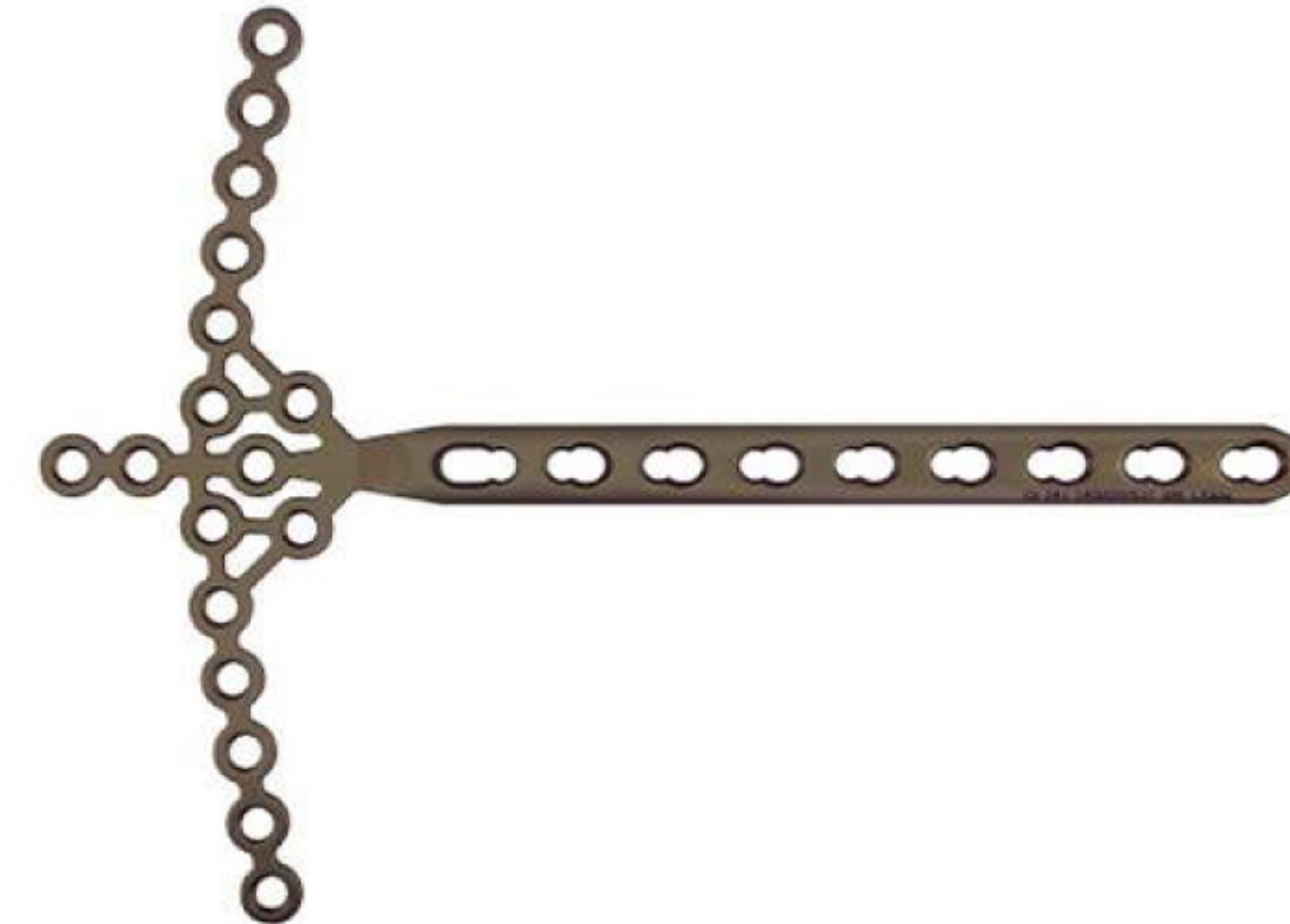

Product No.		Holes	Length
Pure Titanium	Stainless Steel		
6388-3006	6388-5006	6	147
6388-3008	6388-5008	8	173

Note: Select HC3.5 and HA3.5 screws

LARGE BONE LOCKING XOMPRESSION PLATE(COMBINATION HOLE)

LARGE BONE LOCKING PLATE(ROUND HOLE)

6245 | T-Locking Plate

6245-3/5004~6245-3/5008



Product No.		Holes	Length
Pure Titanium	Stainless Steel		
6245-3004	6245-5004	4	87
6245-3005	6245-5005	5	103
6245-3006	6245-5006	6	119
6245-3007	6245-5007	7	135
6245-3008	6245-5008	8	151

Note:Select HC5.0 and HA4.5 screws

6246 | T-Locking Plate

6246-3/5104~6246-3/5208



Product No.		Holes	Length
Pure Titanium	Stainless Steel		
6246-3104	6246-5104	4 L	87
6246-3204	6246-5204	4 R	87
6246-3105	6246-5105	5 L	103
6246-3205	6246-5205	5 R	103
6246-3106	6246-5106	6 L	119
6246-3206	6246-5206	6 R	119
6246-3107	6246-5107	7 L	135
6246-3207	6246-5207	7 R	135
6246-3108	6246-5108	8 L	151
6246-3208	6246-5208	8 R	151

Note:Select HC5.0 and HA4.5 screws

6358 |

Distal Fibula Locking Compression Plate

6358-3/5003~6358-3/5007



Product No.		Holes	Length
Pure Titanium	Stainless Steel		
6358-3003	6358-5003	3	82
6358-3004	6358-5004	4	95
6358-3005	6358-5005	5	108
6358-3006	6358-5006	6	121
6358-3007	6358-5007	7	134

Note:Select HC3.5 and HA3.5 screws

6353 |

Distal Fibula Locking Compression Plate

6353-3/5103~6353-3/5208



Product No.		Holes	Length
Pure Titanium	Stainless Steel		
6353-3103	6353-5103	3 L	60
6353-3203	6353-5203	3 R	60
6353-3104	6353-5104	4 L	72
6353-3204	6353-5204	4 R	72
6353-3105	6353-5105	5 L	84
6353-3205	6353-5205	5 R	84
6353-3106	6353-5106	6 L	96
6353-3206	6353-5206	6 R	96
6353-3107	6353-5107	7 L	108
6353-3207	6353-5207	7 R	108
6353-3108	6353-5108	8 L	120
6353-3208	6353-5208	8 R	120

Note:Select HC3.5 and HA3.5 screws

6114 |

LC-DCP Tibial Locking Compression Plate

6114-3/5004~6114-3/5012



Product No.		Holes	Length
Pure Titanium	Stainless Steel		
6114-3004	6114-5004	4	88
6114-3005	6114-5005	5	106
6114-3006	6114-5006	6	124
6114-3007	6114-5007	7	142
6114-3008	6114-5008	8	160
6114-3009	6114-5009	9	178
6114-3010	6114-5010	10	196
6114-3011	6114-5011	11	214
6114-3012	6114-5012	12	232

Note:Select HC5.0 and HA4.5 screws

6116 |

LC-DCP Femur Locking Compression Plate

6116-3/5004~6116-3/5014



Product No.		Holes	Length
Pure Titanium	Stainless Steel		
6116-3004	6116-5004	4	88
6116-3005	6116-5005	5	106
6116-3006	6116-5006	6	124
6116-3007	6116-5007	7	142
6116-3008	6116-5008	8	160
6116-3009	6116-5009	9	178
6116-3010	6116-5010	10	196
6116-3011	6116-5011	11	214
6116-3012	6116-5012	12	232
6116-3013	6116-5013	13	250
6116-3014	6116-5014	14	268

Note:Select HC5.0 and HA4.5 screws

6348 |

Proximal Femur Locking Compression Plate

6348-3/5104~6348-3/5211



Product No.		Holes	Length
Pure Titanium	Stainless Steel		
6348-3104	6348-5104	4 L	120
6348-3204	6348-5204	4 R	120
6348-3105	6348-5105	5 L	138
6348-3205	6348-5205	5 R	138
6348-3106	6348-5106	6 L	156
6348-3206	6348-5206	6 R	156
6348-3107	6348-5107	7 L	174
6348-3207	6348-5207	7 R	174
6348-3108	6348-5108	8 L	192
6348-3208	6348-5208	8 R	192
6348-3109	6348-5109	9 L	209
6348-3209	6348-5209	9 R	209
6348-3110	6348-5110	10 L	227
6348-3210	6348-5210	10 R	227
6348-3111	6348-5111	11 L	245
6348-3211	6348-5211	11 R	245

Note:Select HC6.5, HC5.0 and HA4.5 screws

6382 |

Proximal Femur Locking Compression Plate

6382-3/5104~6382-3/5211



Product No.		Holes	Length
Pure Titanium	Stainless Steel		
6382-3104	6382-5104	4 L	120
6382-3204	6382-5204	4 R	120
6382-3105	6382-5105	5 L	138
6382-3205	6382-5205	5 R	138
6382-3106	6382-5106	6 L	156
6382-3206	6382-5206	6 R	156
6382-3107	6382-5107	7 L	174
6382-3207	6382-5207	7 R	174
6382-3108	6382-5108	8 L	192
6382-3208	6382-5208	8 R	192
6382-3109	6382-5109	9 L	209
6382-3209	6382-5209	9 R	209
6382-3110	6382-5110	10 L	227
6382-3210	6382-5210	10 R	227
6382-3111	6382-5111	11 L	245
6382-3211	6382-5211	11 R	245

Note:Select HC6.5, HC5.0 and HA4.5 screws

LARGE BONE LOCKING PLATE(ROUND HOLE)

6331 |
Proximal Femur Locking Compression Plate
6331-3/5105~6331-3/5211



Product No.		Holes	Length
Pure Titanium	Stainless Steel		
6331-3105	6331-5105	5 L	177
6331-3205	6331-5205	5 R	177
6331-3106	6331-5106	6 L	197
6331-3206	6331-5206	6 R	197
6331-3107	6331-5107	7 L	217
6331-3207	6331-5207	7 R	217
6331-3108	6331-5108	8 L	237
6331-3208	6331-5208	8 R	237
6331-3109	6331-5109	9 L	256
6331-3209	6331-5209	9 R	256
6331-3110	6331-5110	10 L	276
6331-3210	6331-5210	10 R	276
6331-3111	6331-5111	11 L	316
6331-3211	6331-5211	11 R	316

Note:Select HC5.0 and HA4.5 screws

6338 |
Proximal Femur Locking Compression Plate
6338-3/5104~6338-3/5214



Product No.		Holes	Length
Pure Titanium	Stainless Steel		
6338-3104	6338-5104	4 L	104
6338-3204	6338-5204	4 R	104
6338-3105	6338-5105	5 L	121
6338-3205	6338-5205	5 R	121
6338-3106	6338-5106	6 L	138
6338-3206	6338-5206	6 R	138
6338-3108	6338-5108	8 L	172
6338-3208	6338-5208	8 R	172
6338-3110	6338-5110	10 L	206
6338-3210	6338-5210	10 R	206
6338-3112	6338-5112	12 L	240
6338-3212	6338-5212	12 R	240
6338-3114	6338-5114	14 L	274
6338-3214	6338-5214	14 R	274

Note:Select HC5.0 and HA4.5 screws

6327 |
Distal Femur Lateral Locking Compression Plate
6327-3/5105~6327-3/5213



Product No.		Holes	Length
Pure Titanium	Stainless Steel		
6327-3105	6327-5105	5 L	157
6327-3205	6327-5205	5 R	157
6327-3107	6327-5107	7 L	196
6327-3207	6327-5207	7 R	196
6327-3109	6327-5109	9 L	236
6327-3209	6327-5209	9 R	236
6327-3111	6327-5111	11 L	275
6327-3211	6327-5211	11 R	275
6327-3113	6327-5113	13 L	313
6327-3213	6327-5213	13 R	313

Note:Select HC5.0 and HA4.5 screws

(LISS)6346 |
Distal Femur Lateral Locking Compression Plate
6346-3/5105 ~ 6346-3/5213



Product No.		Holes	Length
Pure Titanium	Stainless Steel		
6346-3105	6346-5105	5 L	156
6346-3205	6346-5205	5 R	156
6346-3107	6346-5107	7 L	196
6346-3207	6346-5207	7 R	196
6346-3109	6346-5109	9 L	236
6346-3209	6346-5209	9 R	236
6346-3111	6346-5111	11 L	276
6346-3211	6346-5211	11 R	276
6346-3113	6346-5113	13 L	315
6346-3213	6346-5213	13 R	315

Note:Select HC5.0 and HA4.5 screws

LARGE BONE LOCKING PLATE(ROUND HOLE)

6369 |
Proximal Femur Locking Compression Plate
6369-3/5104~6369-3/5204



6325 |
Proximal Tibial Lateral Locking Compression Plate
6325-3/5104~6325-3/5214



(LISS)6345 |
Proximal Tibial Lateral Locking Compression Plate
6345-3/5105 ~ 6345-3/5213



6218 |
Reconstruction L-Locking Plate
6218-3/5104~6218-3/5210



Product No.		Holes	Length
Pure Titanium	Stainless Steel		
6369-3104	6369-5104	4 L	51
6369-3204	6369-5204	4 R	51

Note:Select HC5.0 and HA4.5 screws

Product No.		Holes	Length
Pure Titanium	Stainless Steel		
6325-3104	6325-5104	4 L	119
6325-3204	6325-5204	4 R	119
6325-3105	6325-5105	5 L	133
6325-3205	6325-5205	5 R	133
6325-3107	6325-5107	7 L	167
6325-3207	6325-5207	7 R	167
6325-3109	6325-5109	9 L	201
6325-3209	6325-5209	9 R	201
6325-3111	6325-5111	11 L	235
6325-3211	6325-5211	11 R	235
6325-3113	6325-5113	13 L	269
6325-3213	6325-5213	13 R	269
6325-3114	6325-5114	14 L	283
6325-3214	6325-5214	14 R	283

Note:Select HC5.0 and HA4.5 screws

Product No.		Holes	Length
Pure Titanium	Stainless Steel		
6345-3105	6345-5105	5 L	158
6345-3205	6345-5205	5 R	158
6345-3107	6345-5107	7 L	198
6345-3207	6345-5207	7 R	198
6345-3109	6345-5109	9 L	238
6345-3209	6345-5209	9 R	238
6345-3111	6345-5111	11 L	278
6345-3211	6345-5211	11 R	278
6345-3113	6345-5113	13 L	318
6345-3213	6345-5213	13 R	318

Note:Select HC5.0 and HA4.5 screws

Product No.		Holes	Length
Pure Titanium	Stainless Steel		
6218-3104	6218-5104	4 L	83
6218-3204	6218-5204	4 R	83
6218-3105	6218-5105	5 L	99
6218-3205	6218-5205	5 R	99
6218-3106	6218-5106	6 L	115
6218-3206	6218-5206	6 R	115
6218-3107	6218-5107	7 L	131
6218-3207	6218-5207	7 R	131
6218-3108	6218-5108	8 L	147
6218-3208	6218-5208	8 R	147
6218-3109	6218-5109	9 L	163
6218-3209	6218-5209	9 R	163
6218-3110	6218-5110	10 L	179
6218-3210	6218-5210	10 R	179

Note:Select HC5.0 and HA4.5 screws

LARGE BONE LOCKING PLATE(ROUND HOLE)

LARGE BONE LOCKING PLATE(ROUND HOLE)

6219 |
Reconstruction T-Locking Plate
6219-3/5004~6219-3/5010



Product No.		Holes	Length
Pure Titanium	Stainless Steel		
6219-3004	6219-5004	4	83
6219-3005	6219-5005	5	99
6219-3006	6219-5006	6	115
6219-3007	6219-5007	7	131
6219-3008	6219-5008	8	147
6219-3009	6219-5009	9	163
6219-3010	6219-5010	10	179

Note: Select HC5.0 and HA4.5 screws

6324 |
Distal Tibial Medial Locking Plate
6324-3/5005~6324-3/5113



Product No.		Holes	Length
Pure Titanium	Stainless Steel		
6324-3105	6324-5105	5 L	121
6324-3205	6324-5205	5 R	121
6324-3107	6324-5107	7 L	157
6324-3207	6324-5207	7 R	157
6324-3109	6324-5109	9 L	193
6324-3209	6324-5209	9 R	193
6324-3111	6324-5111	11 L	229
6324-3211	6324-5211	11 R	229
6324-3113	6324-5113	13 L	265
6324-3213	6324-5213	13 R	265

Note: Select HC3.5 and HA3.5 screws

6340 |
Distal Tibial Medial Locking Plate
6340-3/5005~6340-3/5113



Product No.		Holes	Length
Pure Titanium	Stainless Steel		
6340-3005	6340-5005	5 L	113
6340-3105	6340-5105	5 R	113
6340-3007	6340-5007	7 L	137
6340-3107	6340-5107	7 R	137
6340-3009	6340-5009	9 L	173
6340-3109	6340-5109	9 R	173
6340-3011	6340-5011	11 L	197
6340-3111	6340-5111	11 R	197
6340-3013	6340-5013	13 L	221
6340-3113	6340-5113	13 R	221

Note: Select HC3.5 and HA3.5 screws

6344 |
Distal Tibial Lateral Locking Compression Plate
6344-3/5105~6344-3/5213



Product No.		Holes	Length
Pure Titanium	Stainless Steel		
6344-3105	6344-5105	5 L	105
6344-3205	6344-5205	5 R	105
6344-3107	6344-5107	7 L	137
6344-3207	6344-5207	7 R	137
6344-3109	6344-5109	9 L	169
6344-3209	6344-5209	9 R	169
6344-3111	6344-5111	11 L	201
6344-3211	6344-5211	11 R	201
6344-3113	6344-5113	13 L	233
6344-3213	6344-5213	13 R	233

Note: Select HC5.0 and HA4.5 screws

6220
Distal Lateral Tibial L-Locking Compression Plate
6220-3/5105~6220-3/5214



Product No.		Holes	Length
Pure Titanium	Stainless Steel		
6220-3105	6220-5105	5 L	85
6220-3205	6220-5205	5 R	85
6220-3106	6220-5106	6 L	99
6220-3206	6220-5206	6 R	99
6220-3107	6220-5107	7 L	113
6220-3207	6220-5207	7 R	113
6220-3108	6220-5108	8 L	127
6220-3208	6220-5208	8 R	127
6220-3109	6220-5109	9 L	141
6220-3209	6220-5209	9 R	141
6220-3110	6220-5110	10 L	155
6220-3210	6220-5210	10 R	155
6220-3111	6220-5111	11 L	169
6220-3211	6220-5211	11 R	169
6220-3112	6220-5112	12 L	183
6220-3212	6220-5212	12 R	183
6220-3113	6220-5113	13 L	197
6220-3213	6220-5213	13 R	197
6220-3114	6220-5114	14 L	211
6220-3214	6220-5214	14 R	211

Note: Select HC3.5 and HA3.5 screws

6317 |
Distal Fibula Locking Plate
6317-3/5003~6317-3/5008



Product No.		Holes	Length
Pure Titanium	Stainless Steel		
6317-3003	6317-5003	3	73
6317-3004	6317-5004	4	85
6317-3005	6317-5005	5	97
6317-3006	6317-5006	6	109
6317-3007	6317-5007	7	121
6317-3008	6317-5008	8	133

Note: Select HC3.5 screws

6334 | Calcaneal Locking Plates
6334-3/5100~6334-3/5210



Product No.		Holes	Length
Pure Titanium	Stainless Steel		
6334-3100	6334-5100	Large L	73
6334-3110	6334-5110	Large R	
6334-3200	6334-5200	Small L	58
6334-3210	6334-5210	Small R	

Note: Select HC3.5 screws

6335 | Calcaneal Locking Plate
6335-3/5103~6335-3/5214



Product No.		Holes	Length
Pure Titanium	Stainless Steel		
6335-3103	6335-5103	Long, 3 holes L	80
6335-3113	6335-5113	Long, 3 holes R	
6335-3104	6335-5104	Long, 4 holes L	89
6335-3114	6335-5114	Long, 4 holes R	
6335-3203	6335-5203	Short, 3 holes L	60
6335-3213	6335-5213	Short, 3 holes R	
6335-3204	6335-5204	Short, 4 holes L	69
6335-3214	6335-5214	Short, 4 holes R	

Note: Select HC3.5 screws

LARGE BONE LOCKING PLATE(ROUND HOLE)

6347 |
Calcaneal Locking Plate

6347-3/5159~6347-3/5268



Product No.		Holes	Length
Pure Titanium	Stainless Steel		
6347-3159	6347-5159	2 L	59
6347-3259	6347-5259	2 R	59
6347-3160	6347-5160	2 L	60
6347-3260	6347-5260	2 R	60
6347-3162	6347-5162	2 L	62
6347-3262	6347-5262	2 R	62
6347-3168	6347-5168	2 L	68
6347-3268	6347-5268	2 R	68

Note:Select HC3.5 screws

6217
Reconstruction Curved Pelvic Locking Plate

6217-3/5004~6217-3/5012



Product No.		Holes	Length
Pure Titanium	Stainless Steel		
6217-3004	6217-5004	4	53
6217-3005	6217-5005	5	66
6217-3006	6217-5006	6	79
6217-3007	6217-5007	7	91
6217-3008	6217-5008	8	102
6217-3009	6217-5009	9	113
6217-3010	6217-5010	10	123
6217-3011	6217-5011	11	132
6217-3012	6217-5012	12	141

Note:Select HC3.5 screws

T6114
Small Bone Fracture Instrument Case (Small)

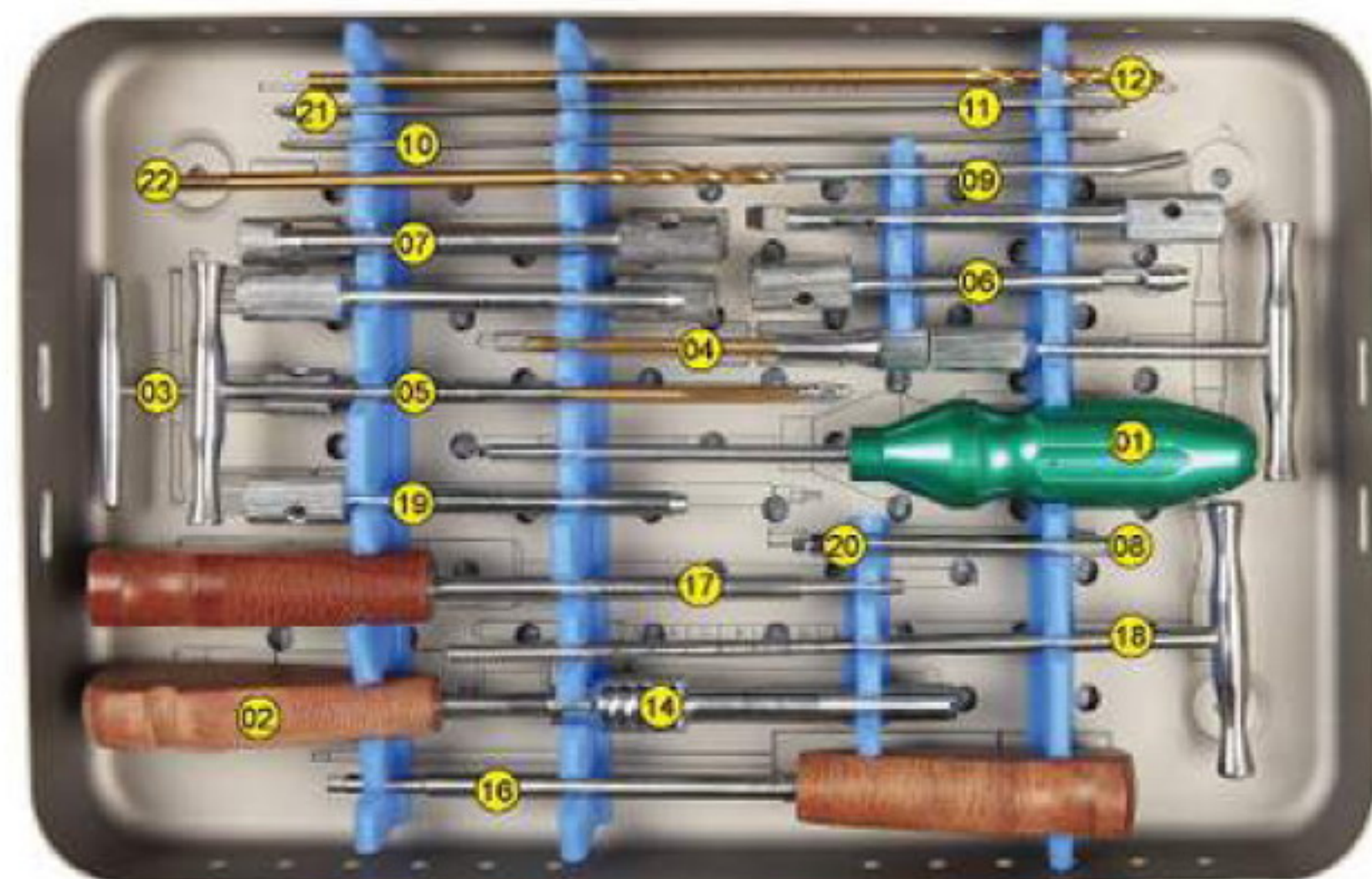

Product No.	Product Name	
T6114-0100		Torque Limiting Screwdriver
T6114-0200	SW3.5	Protected Screw Driver SW3.5
T6114-0300		T-Drill
T6114-0400		Stopper Screw TapΦ5
T6114-0500		Locking Screw Tap
T6114-0600		LCP Drill Guide Sleeve
T6114-0700		LCP Kirscher Wire Guide Sleeve
T6114-0800	SW3.5	Electro-Screw Driver SW3.5
T6114-0900		Wrench Bar
T6114-1000		Guide Pin
T6114-1100		Threaded Guide Pin
T6114-1200		Drill Bit
T6114-1400		Locking Screw Holder

Optional Product

Product No.	Product Name	
T6114-1600	4.0	4.0 Protected Screw Driver
T6114-1700	4.0	Screw Driver,Cannulated
T6114-1800		Screw Tap,Cannulated
T6114-1900	(2.5)	LCP Kirscher Wire Guide Sleeve(2.5)
T6114-1901	(5.0)	LCP Drill Guide Sleeve(5.0)
T6114-2000	SW4	Electro-Screw Driver SW4(Hex)
T6114-2100	(2.5)	Threaded Guide Pin(2.5)
T6114-2200	Φ4.9	Drill Bit,CannulatedΦ4.9

LARGE BONE LOCKING PLATE(ROUND HOLE)

T6113
Large Bone Fracture Locking Plate Instrument (Large)

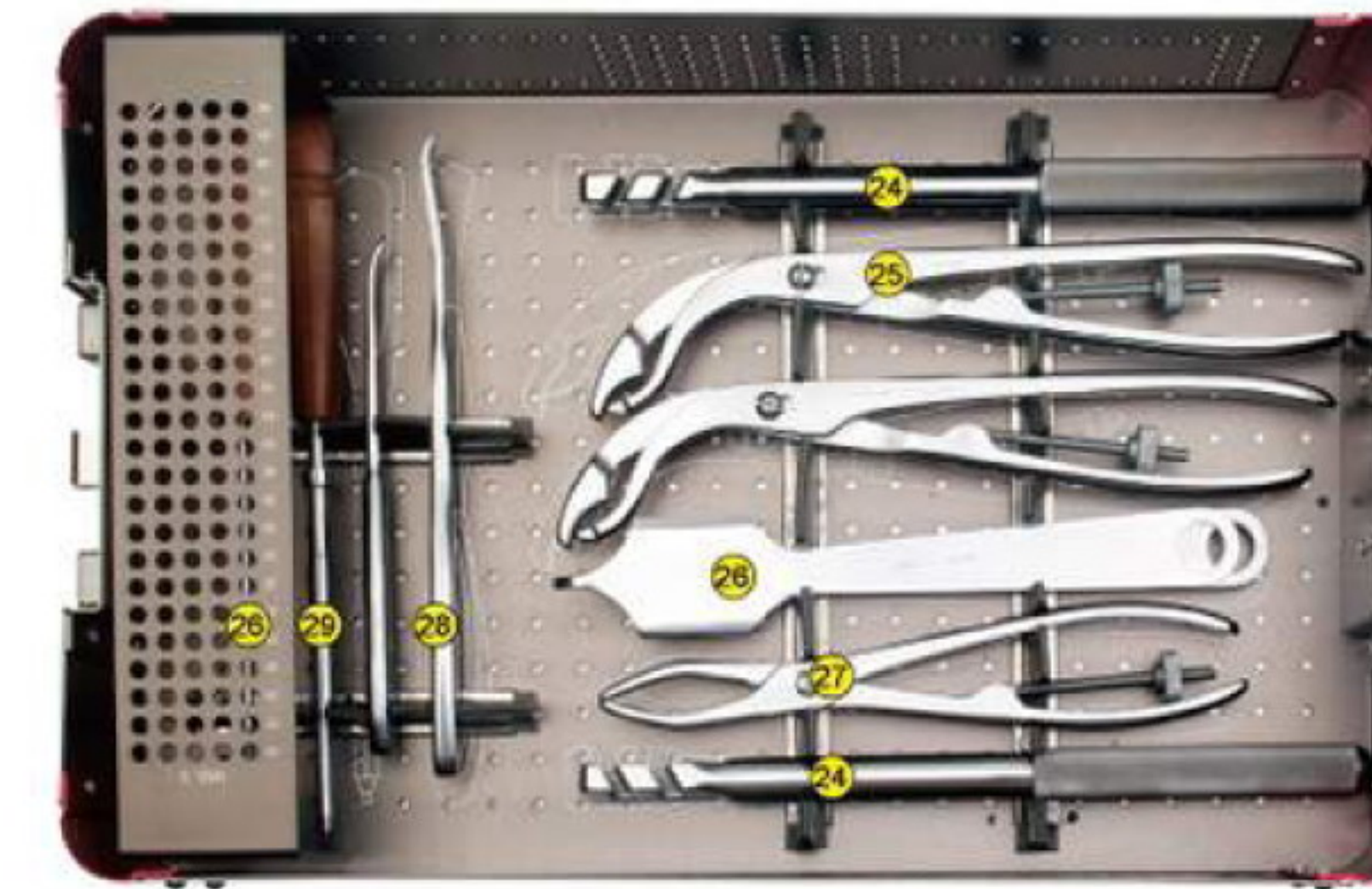
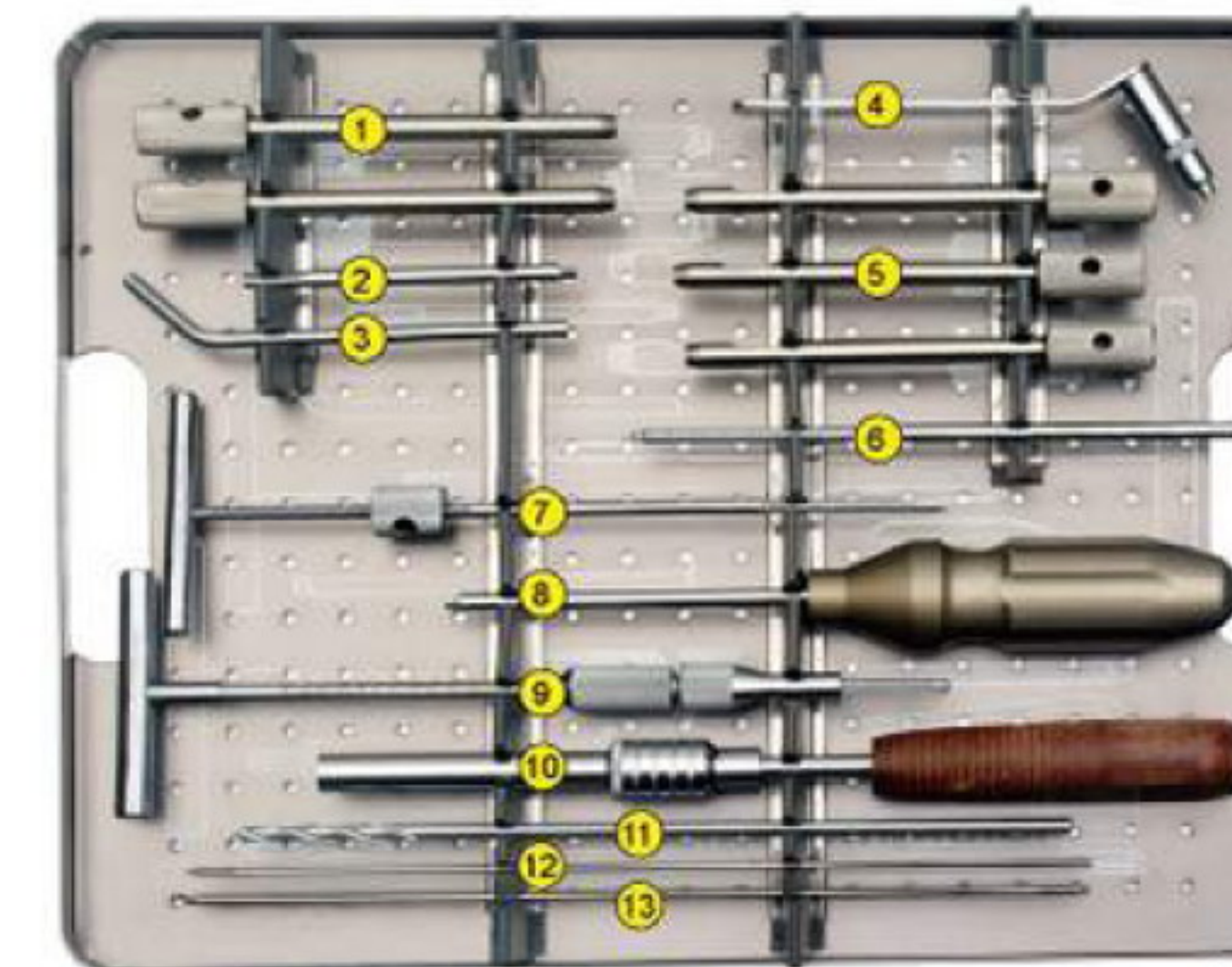
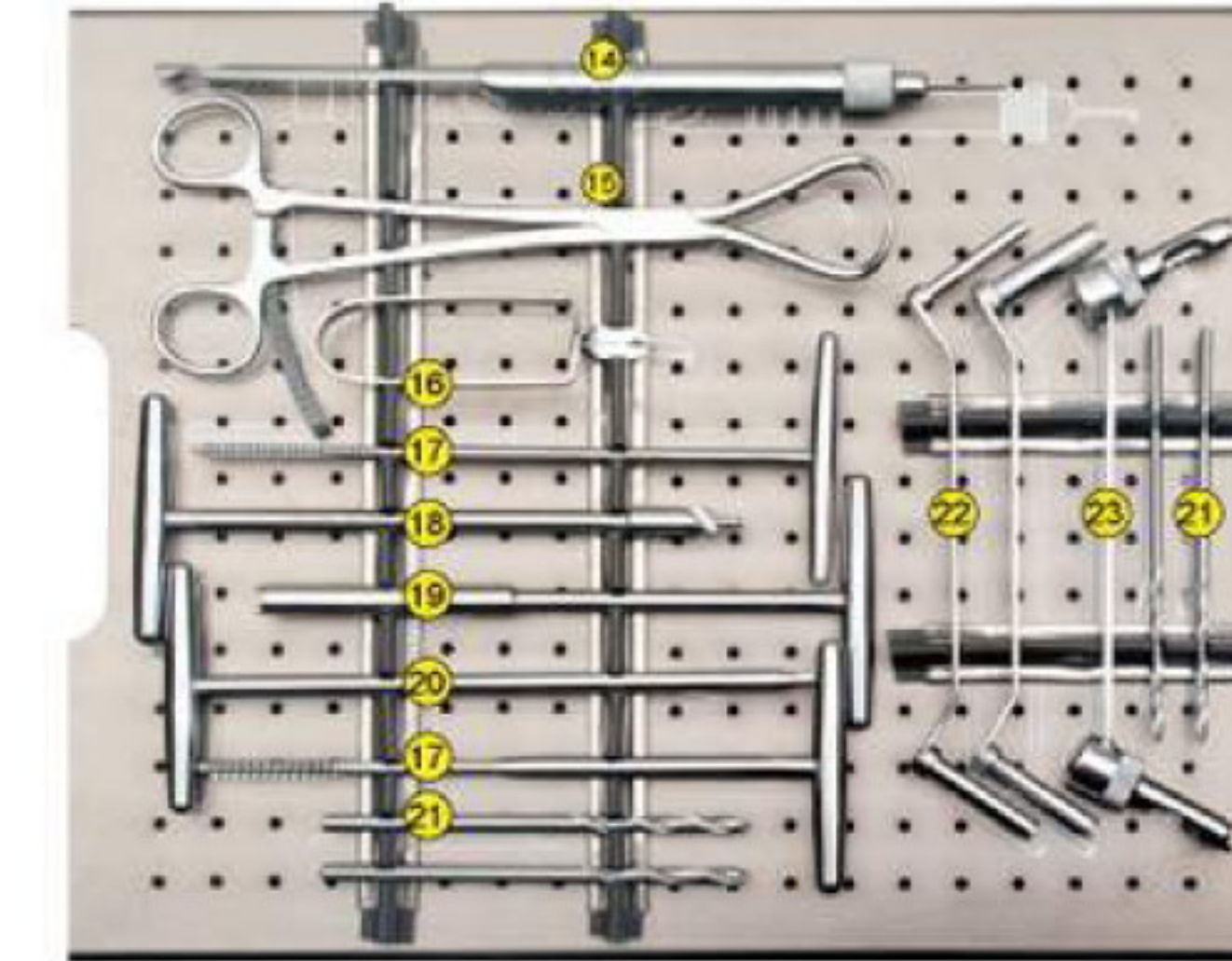

Product No.	Product Name	
T6113-0100		Kischer Wire Guide Sleeve
T6113-0200		Electro-Screw Driver SW3.5
T6113-0300		Wrench Bar
T6113-0500		Drill Guide Sleeve
T6113-0600		Locking Screw Tap
T6113-0700		T-Drill
T6113-0800		Torque Limited Screw Driver SW3.5
T6113-0900	Φ 5	Stopper Screw TapΦ5
T6113-1000	SW3.5	Protected Screw Driver SW3.5
T6113-1100	Φ4.3*250	Drill Bit Φ4.3*250
T6113-1200		Guide Pin
T6113-1300	Φ 2	Guide PinΦ2
T6113-1400		Depth Gauge
T6113-1500		Cusp Reduction Forcep (Large)
T6113-1600		Screw Holder
T6113-1700	HA4.5	Screw Tap HA4.5
T6113-1701	HB6.5	Screw Tap HB6.5
T6113-1800	Φ 8	Countersink Drill Φ8
T6113-1900		Broken Screw Extractor
T6113-2000	SW3.5	Protected Screw Driver SW3.5
T6113-2100	Φ 3.2	Drill Bit Φ3.2
T6113-2101	Φ 4.5	Drill Bit Φ4.5
T6113-2200		Drill GuideΦ4.5
T6113-2300		Double Head Drill Guide Φ4.5
T6113-2400		Bone Plate Bender
T6113-2500		Self-centering Forceps
T6113-2600		Retractor Large
T6113-2700		Reduction Forcep (Large)
T6113-2800		Periosteum Detacher
T6113-2900		Screw-holder Driver
T6113-3000		Screw Anti-skidding Extractor

DHS/DCS
DHS/DCS

DHS/DCS
DHS/DCS

4716 |
DHS Plates (Hex Type)
4716-3/5003~4716-3/5012



Product No.		Holes	Angle	Model		
Pure Titanium	Stainless Steel					
4716-3003	4716-5003	3	135°	DHS Hex-Type		
4716-3004	4716-5004	4				
4716-3005	4716-5005	5				
4716-3006	4716-5006	6				
4716-3007	4716-5007	7				
4716-3008	4716-5008	8				
4716-3009	4716-5009	9				
4716-3010	4716-5010	10				
4716-3011	4716-5011	11				
4716-3012	4716-5012	12				
4717-3003	4717-5003	3			135°	LC-DCP DHS Hex-Type
4717-3004	4717-5004	4				
4717-3005	4717-5005	5				
4717-3006	4717-5006	6				
4717-3007	4717-5007	7				
4717-3008	4717-5008	8				
4717-3009	4717-5009	9				
4717-3010	4717-5010	10				
4717-3011	4717-5011	11				
4717-3012	4717-5012	12				
4718-3003	4718-5003	3	135°	DHS Biplanar Type		
4718-3004	4718-5004	4				
4718-3005	4718-5005	5				
4718-3006	4718-5006	6				
4718-3007	4718-5007	7				
4718-3008	4718-5008	8				
4718-3009	4718-5009	9				
4718-3010	4718-5010	10				
4718-3011	4718-5011	11				
4718-3012	4718-5012	12				

4717 |
LC-DCP DHS Plates
4717-3/5003~4717-3/5012



4718 |
DHS Plates (Ao Type)
4718-3/5003~4718-3/5012



4713 | DCS Plates
4713-3/5005~4713-3/5012



Product No.		Holes	Angle	Model
Pure Titanium	Stainless Steel			
4713-3005	4713-5005	5	95°	DCS
4713-3006	4713-5006	6		
4713-3007	4713-5007	7		
4713-3008	4713-5008	8		
4713-3009	4713-5009	9		
4713-3010	4713-5010	10		
4713-3011	4713-5011	11		
4713-3012	4713-5012	12		
4714-3005	4714-5005	5		
4714-3006	4714-5006	6		
4714-3007	4714-5007	7		
4714-3008	4714-5008	8		
4714-3009	4714-5009	9		
4714-3010	4714-5010	10		
4714-3011	4714-5011	11		
4714-3012	4714-5012	12		

4714 |
LC-DCP DCS Plates
4714-3/5005~4714-3/5012



6717 |
DHS Locking Compression Plate(Hex-Type)
6717-3/5003~6717-3/5012



Product No.		Holes	Angle	Model
Pure Titanium	Stainless Steel			
6717-3003	6717-5003	3	135°	DHS Hex-Type
6717-3004	6717-5004	4		
6717-3005	6717-5005	5		
6717-3006	6717-5006	6		
6717-3007	6717-5007	7		
6717-3008	6717-5008	8		
6717-3009	6717-5009	9		
6717-3010	6717-5010	10		
6717-3011	6717-5011	11		
6717-3012	6717-5012	12		

Note: Select HC5.0 and HB6.5 screws

6713 |
DCS Locking Compression Plate
6713-3/5005~6713-3/5012



Product No.		Holes	Angle	Model
Pure Titanium	Stainless Steel			
6713-3005	6713-5005	5	95°	DCS
6713-3006	6713-5006	6		
6713-3007	6713-5007	7		
6713-3008	6713-5008	8		
6713-3009	6713-5009	9		
6713-3010	6713-5010	10		
6713-3011	6713-5011	11		
6713-3012	6713-5012	12		

Note: Select HC5.0 and HA4.5 screws

4715 |
Lag Screws (Hex Type)
4715-2/5060~4715-2/5115



Product No.		Length	Note	
Pure Titanium	Stainless Steel			
4715-2060	4715-5060	60	Hex Type	
4715-2065	4715-5065	65		
4715-2070	4715-5070	70		
4715-2075	4715-5075	75		
4715-2080	4715-5080	80		
4715-2085	4715-5085	85		
4715-2090	4715-5090	90		
4715-2095	4715-5095	95		
4715-2100	4715-5100	100		
4715-2105	4715-5105	105		
4715-2110	4715-5110	110		
4715-2115	4715-5115	115		
4719-2060	4719-5060	60		Ao Type
4719-2065	4719-5065	65		
4719-2070	4719-5070	70		
4719-2075	4719-5075	75		
4719-2080	4719-5080	80		
4719-2085	4719-5085	85		
4719-2090	4719-5090	90		
4719-2095	4719-5095	95		
4719-2100	4719-5100	100		
4719-2105	4719-5105	105		
4719-2110	4719-5110	110		
4723-2060	4723-5060	60	Blade Screw	
4723-2065	4723-5065	65		
4723-2070	4723-5070	70		
4723-2075	4723-5075	75		
4723-2080	4723-5080	80		
4723-2085	4723-5085	85		
4723-2090	4723-5090	90		
4723-2095	4723-5095	95		
4723-2100	4723-5100	100		
4723-2105	4723-5105	105		
4723-2110	4723-5110	110		

4719 |
Lag Screws (Ao Type)
4719-2/5060~4719-2/5110



4723 |
Lag Screws (Blade Screw)
4723-2/5060~4723-2/5110



T4721
DHS/DCS Instrument Case (Small)

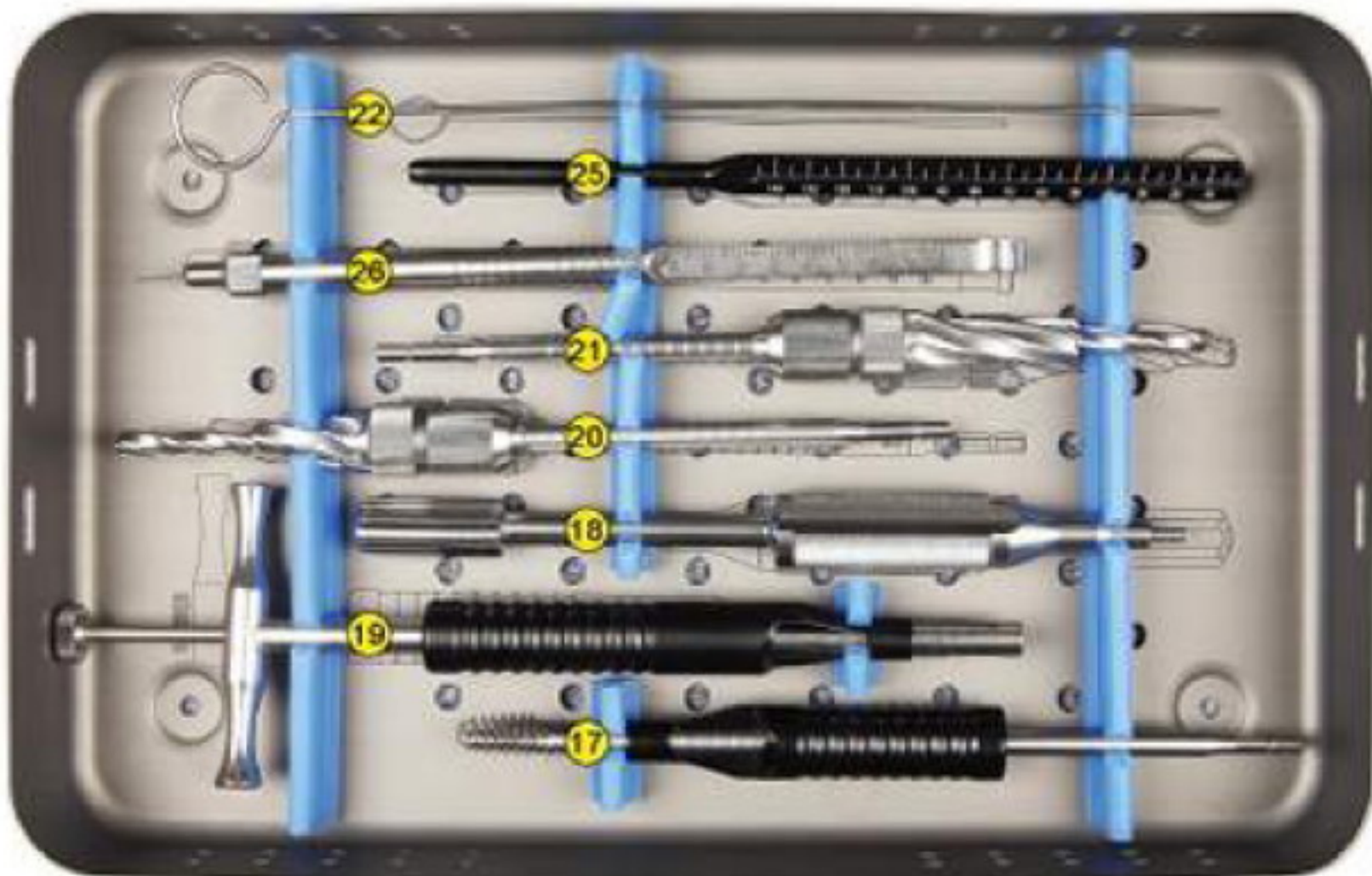
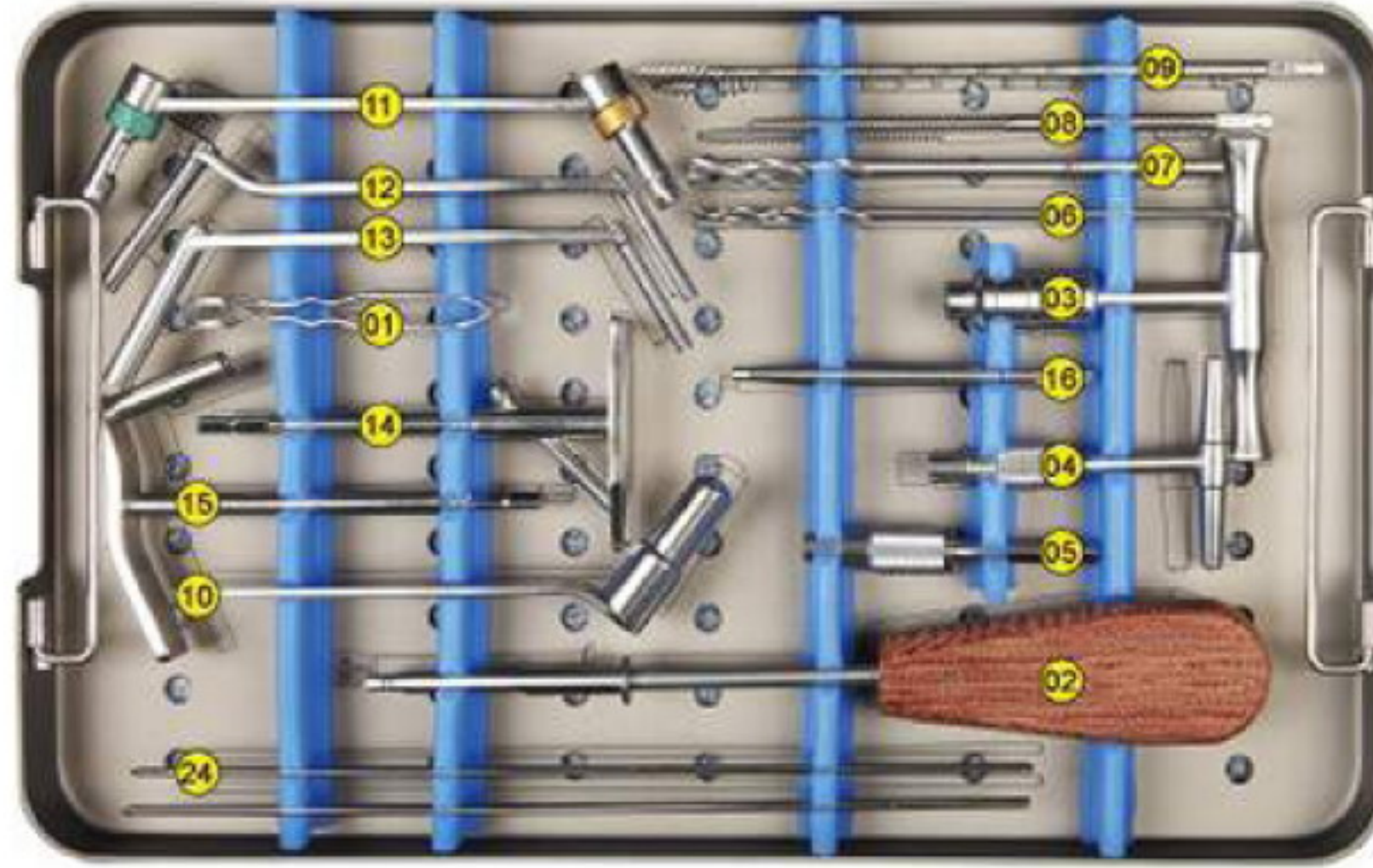

Product No.	Product Name	
T4721-0100	R1.6	Screw Holding Forceps
T4721-0200	SW3.5	Hexagonal Screwdriver
T4721-0300	φ55225	Quick Connecting Handle (T)
T4721-0400		Quick Connecting Handle (Small T)
T4721-0500		Quick Coupling Connector
T4721-0600	φ3.2 L=150	Drill Bit φ3.2
T4721-0700	L=151	Drill Bit φ4.5
T4721-0800	φ4.5 HA4.5 P=1.75	Screw Tap HA4.5
T4721-0900	φ6.5 HB6.5 P=2.75	Screw Tap HA6.5
T4721-1000	φ2.5/φ12.5	Guide Wire Reductor φ2.5/φ12.5
T4721-1100	φ3.2	Double Head Drill Guide
T4721-1200	φ3.2/φ4.5	Long Slot Drill Guide
T4721-1300	φ3.2/φ6.5	Long Slot Drill Guide
T4721-1400	DHS 135°	135° Driu Duide
T4721-1500	DHS 95°	95° Driu Duide
T4721-1600	SW3.5	Screw Driver SW3.5
T4721-1700	φ12.5 P=3	Lag Screw Tapφ12
T4721-1800	M5/φ7	Compressor
T4721-1900	SW8/φ5.5	Lag Screw Extrator
T4721-2000		DHS Combination Reamer
T4721-2100		DCS Combination Reamer
T4721-2200	φ2.5	Cleaning Stylet φ2.5
T4721-2300	φ2.5*250	Guide Pin
T4721-2400	φ2.5*250	Threaded Guide Pin
T4721-2500	2.5*250	Guide Pin Measuring Gauge
T4721-2600	45mm φ27	Depth Gauge

4401/2 |
Straight Phalange/Metacarpal Plates
4401/2-3/5002-4401/2-3/5008



4403/4 |
T- Phalange/Metacarpal Plates
4403/4-3/5002-4403/4-3/5006



4405/6 |
L- Phalange/Metacarpal Plates
4405/6-3/5102-4405/6-3/5206



4407/8 |
L- Phalange/Metacarpal Plates, Oblique
4407/8-3/5102-4407/8-3/5206



4409 |
W- Metacarpal Plates
4409-3/5102



Product Name	Product No.		Holes	Length
	Pure Titanium	Stainless Steel		
Straight Phalange Plates	4401-3002	4401-5002	2	11
	4401-3003	4401-5003	3	17
	4401-3004	4401-5004	4	23
	4401-3005	4401-5005	5	29
	4401-3006	4401-5006	6	34
Straight Metacarpal Plates	4402-3002	4402-5002	2	15
	4402-3003	4402-5003	3	23
	4402-3004	4402-5004	4	31
	4402-3005	4402-5005	5	39
	4402-3006	4402-5006	6	47
	4402-3007	4402-5007	7	55
T- Phalange Plates	4403-3002	4403-5002	2	20
	4403-3003	4403-5003	3	28
	4403-3004	4403-5004	4	35
	4403-3005	4403-5005	5	43
T- Metacarpal Plates	4403-3006	4403-5006	6	50
	4404-3002	4404-5002	2	25
	4404-3003	4404-5003	3	33
	4404-3004	4404-5004	4	41
	4404-3005	4404-5005	5	49
	4404-3006	4404-5006	6	57
L- Phalange Plates	4405-3102	4405-5102	2 L	19
	4405-3202	4405-5202	2 R	19
	4405-3103	4405-5103	3 L	25
	4405-3203	4405-5203	3 R	25
	4405-3104	4405-5104	4 L	31
	4405-3204	4405-5204	4 R	31
	4405-3105	4405-5105	5 L	37
	4405-3205	4405-5205	5 R	37
	4405-3106	4405-5106	6 L	43
	4405-3206	4405-5206	6 R	43
L- Metacarpal Plates	4406-3102	4406-5102	2 L	25
	4406-3202	4406-5202	2 R	25
	4406-3103	4406-5103	3 L	33
	4406-3203	4406-5203	3 R	33
	4406-3104	4406-5104	4 L	41
	4406-3204	4406-5204	4 R	41
	4406-3105	4406-5105	5 L	49
	4406-3205	4406-5205	5 R	49
	4406-3106	4406-5106	6 L	57
	4406-3206	4406-5206	6 R	57
L- Phalange Plates, Oblique	4407-3102	4407-5102	2 L	20
	4407-3202	4407-5202	2 R	20
	4407-3103	4407-5103	3 L	26
	4407-3203	4407-5203	3 R	26
	4407-3104	4407-5104	4 L	32
	4407-3204	4407-5204	4 R	32
	4407-3105	4407-5105	5 L	38
	4407-3205	4407-5205	5 R	38
	4407-3106	4407-5106	6 L	44
	4407-3206	4407-5206	6 R	44
L- Metacarpal Plates, Oblique	4408-3102	4408-5102	2 L	27
	4408-3202	4408-5202	2 R	27
	4408-3103	4408-5103	3 L	35
	4408-3203	4408-5203	3 R	35
	4408-3104	4408-5104	4 L	43
	4408-3204	4408-5204	4 R	43
	4408-3105	4408-5105	5 L	51
	4408-3205	4408-5205	5 R	51
	4408-3106	4408-5106	6 L	59
	4408-3206	4408-5206	6 R	59
W- Metacarpal Plates	4409-3102	4409-5102	7	45

Note:select HA2 screws

MINI LOCKING PLATE

6401/2 |
Straight Phalange/Metacarpal Locking Plates
6401/2-3/5002-6401/2-3/5008



6403/4 |
T- Phalange/Metacarpal Locking Plates
6403/4-3/5002-6403/4-3/5006



6405/6 |
L- Phalange/Metacarpal Locking Plates
6405/6-3/5102-6405/6-3/5206



6407/8 |
L- Phalange/Metacarpal Locking Plates, Oblique
6407/8-3/5102-6407/8-3/5206



6409 |
W- Metacarpal Locking Plates
6409-3/5102



Product Name	Product No.		Holes	Length
	Pure Titanium	Stainless Steel		
Straight Phalange Locking Plates	6401-3002	6401-5002	2	11
	6401-3003	6401-5003	3	17
	6401-3004	6401-5004	4	23
	6401-3005	6401-5005	5	29
	6401-3006	6401-5006	6	34
	6402-3002	6402-5002	2	15
Straight Metacarpal Locking Plates	6402-3003	6402-5003	3	23
	6402-3004	6402-5004	4	31
	6402-3005	6402-5005	5	39
	6402-3006	6402-5006	6	47
	6402-3007	6402-5007	7	55
	6402-3008	6402-5008	8	63
T- Phalange Locking Plates	6403-3002	6403-5002	2	20
	6403-3003	6403-5003	3	28
	6403-3004	6403-5004	4	35
	6403-3005	6403-5005	5	43
	6403-3006	6403-5006	6	50
	6404-3002	6404-5002	2	25
T- Metacarpal Locking Plates	6404-3003	6404-5003	3	33
	6404-3004	6404-5004	4	41
	6404-3005	6404-5005	5	49
	6404-3006	6404-5006	6	57
	6405-3102	6405-5102	2 L	19
	6405-3202	6405-5202	2 R	19
L- Phalange Locking Plates	6405-3103	6405-5103	3 L	25
	6405-3203	6405-5203	3 R	25
	6405-3104	6405-5104	4 L	31
	6405-3204	6405-5204	4 R	31
	6405-3105	6405-5105	5 L	37
	6405-3205	6405-5205	5 R	37
L- Metacarpal Locking Plates	6405-3106	6405-5106	6 L	43
	6405-3206	6405-5206	6 R	43
	6406-3102	6406-5102	2 L	25
	6406-3202	6406-5202	2 R	25
	6406-3103	6406-5103	3 L	33
	6406-3203	6406-5203	3 R	33
L- Metacarpal Locking Plates	6406-3104	6406-5104	4 L	41
	6406-3204	6406-5204	4 R	41
	6406-3105	6406-5105	5 L	49
	6406-3205	6406-5205	5 R	49
	6406-3106	6406-5106	6 L	57
	6406-3206	6406-5206	6 R	57
L- Phalange Locking Plates, Oblique	6407-3102	6407-5102	2 L	20
	6407-3202	6407-5202	2 R	20
	6407-3103	6407-5103	3 L	26
	6407-3203	6407-5203	3 R	26
	6407-3104	6407-5104	4 L	32
	6407-3204	6407-5204	4 R	32
L- Phalange Locking Plates, Oblique	6407-3105	6407-5105	5 L	38
	6407-3205	6407-5205	5 R	38
	6407-3106	6407-5106	6 L	44
	6407-3206	6407-5206	6 R	44
	6408-3102	6408-5102	2 L	27
	6408-3202	6408-5202	2 R	27
L- Metacarpal Locking Plates, Oblique	6408-3103	6408-5103	3 L	35
	6408-3203	6408-5203	3 R	35
	6408-3104	6408-5104	4 L	43
	6408-3204	6408-5204	4 R	43
	6408-3105	6408-5105	5 L	51
	6408-3205	6408-5205	5 R	51
W- Metacarpal Locking Plates	6408-3106	6408-5106	6 L	59
	6408-3206	6408-5206	6 R	59
	6409-3102	6409-5102	7	45

Note:select HC2 screws

MINI LOCKING PLATE

T4400 |
Mini Fracture Instrument Case

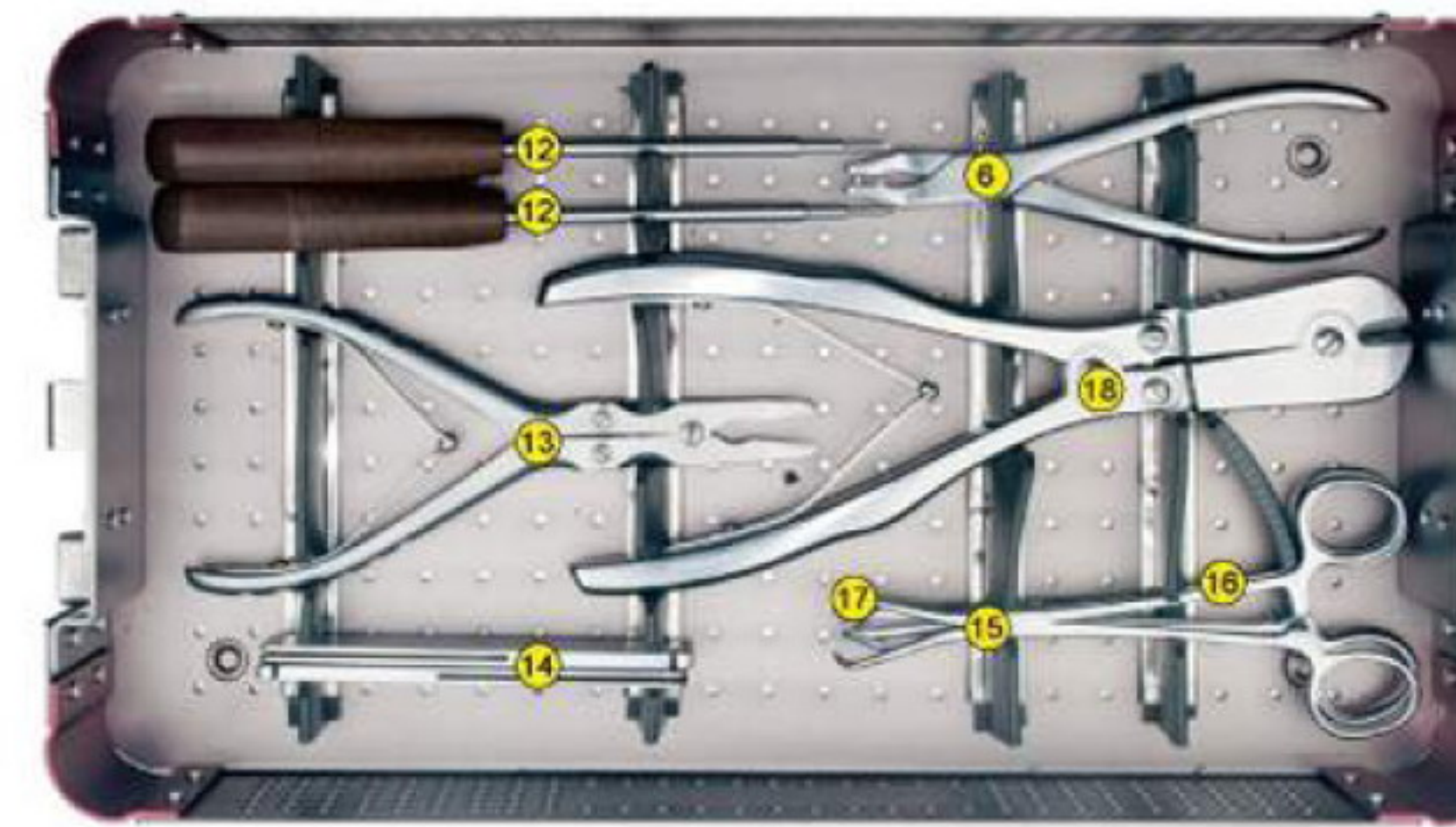
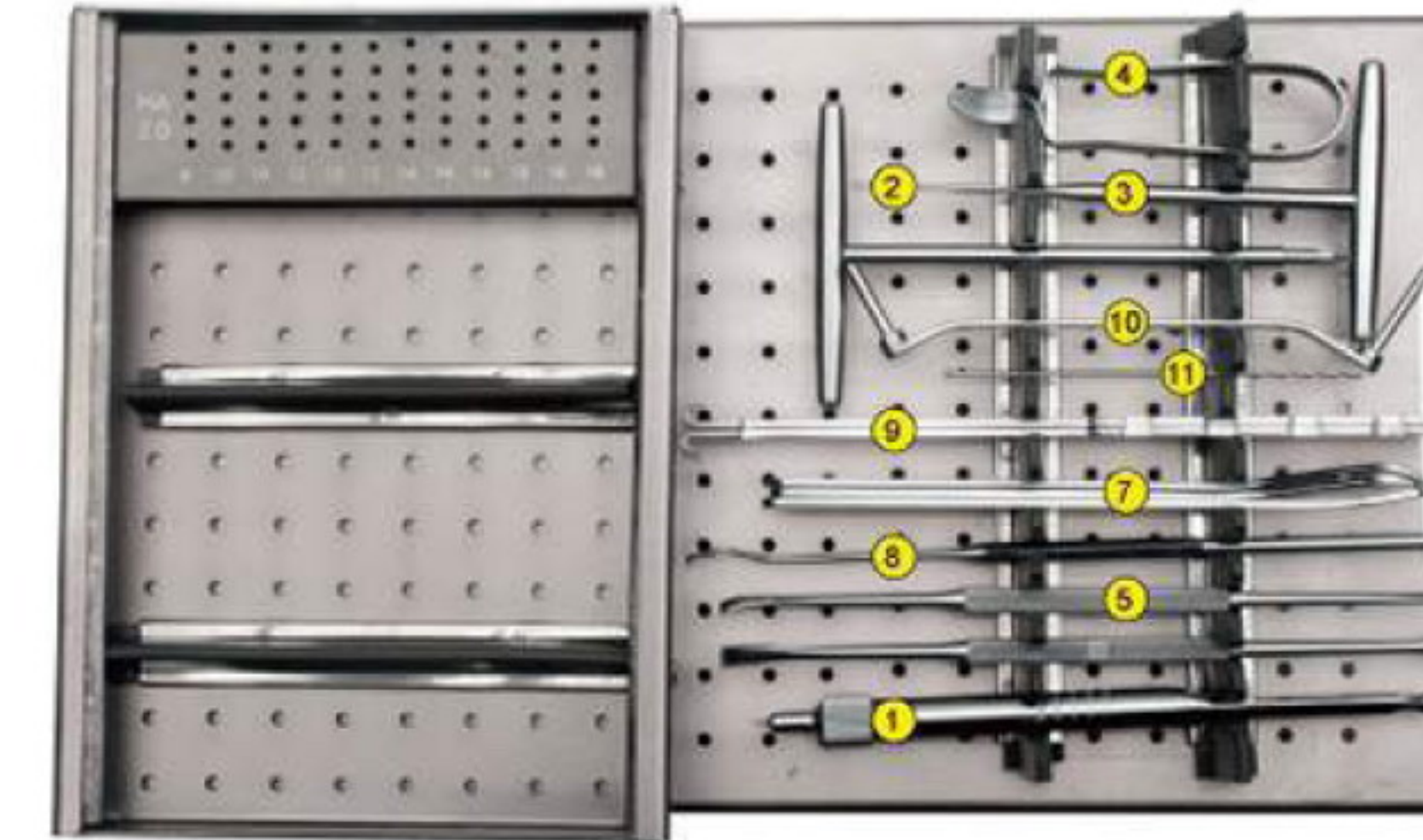

Product No.	Product Name	
T4400-0100		Depth Gauge
T4400-0200	HA2.0	Screw Tap HA2.0
T4400-0300		Countersink Drill
T4400-0400		Screw Holding Forceps
T4400-0500		Periosteum Detacher
T4400-0600		Plate Bender
T4400-0700		Periosteal Retractor
T4400-0800		Sharp Hook
T4400-0900		Skin Retractor
T4400-1000	HA2.0	Drill Sleeve
T4400-1100	∅ 1.5*80	Drill Bit
T4400-1200		Screw Driver (Square)
T4400-1300		Biarticular Bone
T4400-1400		Plate Bending Wrench
T4400-1500		Reduction Forceps
T4400-1600		Curved Reduction Forceps
T4400-1700		Cusp Reduction Forceps
T4400-1800		Wire Cutter

PEDIATRIC BONE PLATE

4130 |
Pediatric 1/3 Tubular Plate
4130-3/5004~4130-3/5010



Product No.		Holes	Length
Pure Titanium	Stainless Steel		
4130-3004	4130-5004	4	40
4130-3005	4130-5005	5	50
4130-3006	4130-5006	6	60
4130-3007	4130-5007	7	70
4130-3008	4130-5008	8	80
4130-3009	4130-5009	9	90
4130-3010	4130-5010	10	100

Note: Select HA2.7 screws

LC-DCP 4131 |
Pediatric Reconstruction Plate
4131-3/5004~4131-3/5010



Product No.		Holes	Length
Pure Titanium	Stainless Steel		
4131-3004	4131-5004	4	40
4131-3005	4131-5005	5	50
4131-3006	4131-5006	6	60
4131-3007	4131-5007	7	70
4131-3008	4131-5008	8	80
4131-3009	4131-5009	9	90
4131-3010	4131-5010	10	100

Note: Select HA2.7 screws

4132 |
Pediatric Reconstruction Plate
4132-3/5004~4132-3/5010



Product No.		Holes	Length
Pure Titanium	Stainless Steel		
4132-3004	4132-5004	4	40
4132-3005	4132-5005	5	50
4132-3006	4132-5006	6	60
4132-3007	4132-5007	7	70
4132-3008	4132-5008	8	80
4132-3009	4132-5009	9	90
4132-3010	4132-5010	10	100

Note: Select HA2.7 screws

4133 |
Pediatric Bone Plate
4133-3/5022~4133-3/5026



Product No.		Holes	Length
Pure Titanium	Stainless Steel		
4133-3022	4133-5022	2	26
4133-3026	4133-5026	2	26

Note: Select HA4.5 cannulated screws and HA4.5 screws

PEDIATRIC LOCKING PLATE

6131 |
LCP-DCP Pediatric Small bone Locking Plate
6131-3/5004~6131-3/5010



Product No.		Holes	Length
Pure Titanium	Stainless Steel		
6131-3004	6131-5004	4	50
6131-3005	6131-5005	5	60
6131-3006	6131-5006	6	70
6131-3007	6131-5007	7	80
6131-3008	6131-5008	8	90
6131-3009	6131-5009	9	100
6131-3010	6131-5010	10	110

Note: Select HC3.5 screws

6132 |
Pediatric Reconstruction Locking Plate
6132-3/5004~6132-3/5010



Product No.		Holes	Length
Pure Titanium	Stainless Steel		
6132-3004	6132-5004	4	48
6132-3005	6132-5005	5	60
6132-3006	6132-5006	6	72
6132-3007	6132-5007	7	84
6132-3008	6132-5008	8	96
6132-3009	6132-5009	9	108
6132-3010	6132-5010	10	120

Note: Select HC3.5 screws

4125 |



Product No.		Holes	Length
Pure Titanium	Stainless Steel		
4125-3004	4125-5004	4	36
4125-3005	4125-5005	5	44
4125-3006	4125-5006	6	52
4125-3007	4125-5007	7	60
4125-3008	4125-5008	8	68
4125-3009	4125-5009	9	76
4125-3010	4125-5010	10	84

Note: Select HA2.7 screws

6370 |
Pediatric Proximal Femoral Locking Plate
6370-3/5003~6370-3/5008



Product No.		Holes	Length
Pure Titanium	Stainless Steel		
6370-3003	6370-5003	3	50
6370-3004	6370-5004	4	60
6370-3005	6370-5005	5	70
6370-3006	6370-5006	6	80
6370-3007	6370-5007	7	90
6370-3008	6370-5008	8	100

Note: Select HC3.5 and HA2.7 screws

6371 |
Pediatric Proximal Femoral Locking Plate
6371-3/5003~6371-3/5008



Product No.		Holes	Length
Pure Titanium	Stainless Steel		
6371-3003	6371-5003	3	74
6371-3004	6371-5004	4	86
6371-3005	6371-5005	5	98
6371-3006	6371-5006	6	110
6371-3007	6371-5007	7	122
6371-3008	6371-5008	8	134

Note: Select HC3.5 and HA2.7 screws

PEDIATRIC LOCKING PLATE

METAL BONE SCREW/METAL LOCKING BONE SCREW

6373 |
Pediatric Distal Humeral Locking Plate
6373-3/5005~6373-3/5008



Product No.		Holes	Length
Pure Titanium	Stainless Steel		
6373-3005	6373-5005	5	65
6373-3006	6373-5006	6	77
6373-3007	6373-5007	7	89
6373-3008	6373-5008	8	101

Note: Select HC3.5 screws

6240 |
Pediatric Distal Femoral T-Locking Plate
6240-3/5003~6240-3/5007



Product No.		Holes	Length
Pure Titanium	Stainless Steel		
6240-3003	6240-5003	3	54
6240-3004	6240-5004	4	66
6240-3005	6240-5005	5	78
6240-3006	6240-5006	6	90
6240-3007	6240-5007	7	102

Note: Select HC3.5 screws

6239 |
Pediatric Proximal Tibial L-Locking Plate
6239-3/5103~6239-3/5207



Product No.		Holes	Length
Pure Titanium	Stainless Steel		
6239-3103	6239-5103	3 L	54
6239-3203	6239-5203	3 R	
6239-3104	6239-5104	4 L	66
6239-3204	6239-5204	4 R	
6239-3105	6239-5105	5 L	78
6239-3205	6239-5205	5 R	
6239-3106	6239-5106	6 L	90
6239-3206	6239-5206	6 R	
6239-3107	6239-5107	7 L	102
6239-3207	6239-5207	7 R	

Note: Select HC3.5 screws

4511 |
Cortex Screw HA2.0 (Fully Threaded)
4511-2/5B06~4511-2/5B20



4511 |
Cortex Screw HA2.5 (Fully Threaded)
4511-2/5010~4511-3/5030



4511 |
Cortex Screw HA2.7 (Fully Threaded)
4511-2/5210~4511-2/5230



4511 |
Cortex Screw HA3.5 (Fully Threaded)
4511-2/5E12~4511-2/5E50



Product No.		Diameter of Screw	Length
Titanium Alloy	Stainless Steel		
4511-2B06	4511-5B06	2.0	6
4511-2B08	4511-5B08		8
4511-2B10	4511-5B10		10
4511-2B12	4511-5B12		12
4511-2B14	4511-5B14		14
4511-2B16	4511-5B16		16
4511-2B18	4511-5B18		18
4511-2B20	4511-5B20		20

Product No.		Diameter of Screw	Length
Titanium Alloy	Stainless Steel		
4511-2010	4511-5010	2.5	10
4511-2012	4511-5012		12
4511-2014	4511-5014		14
4511-2016	4511-5016		16
4511-2018	4511-5018		18
4511-2020	4511-5020		20
4511-2022	4511-5022		22
4511-2024	4511-5024		24
4511-2026	4511-5026		26
4511-2028	4511-5028		28
4511-2030	4511-5030		30

Product No.		Diameter of Screw	Length
Titanium Alloy	Stainless Steel		
4511-2210	4511-5210	2.7	10
4511-2212	4511-5212		12
4511-2214	4511-5214		14
4511-2216	4511-5216		16
4511-2218	4511-5218		18
4511-2220	4511-5220		20
4511-2222	4511-5222		22
4511-2224	4511-5224		24
4511-2226	4511-5226		26
4511-2228	4511-5228		28
4511-2230	4511-5230		30

Product No.		Diameter of Screw	Length
Titanium Alloy	Stainless Steel		
4511-2E12	4511-5E12	3.5	12
4511-2E14	4511-5E14		14
4511-2E16	4511-5E16		16
4511-2E18	4511-5E18		18
4511-2E20	4511-5E20		20
4511-2E22	4511-5E22		22
4511-2E24	4511-5E24		24
4511-2E26	4511-5E26		26
4511-2E28	4511-5E28		28
4511-2E30	4511-5E30		30
4511-2E32	4511-5E32		32
4511-2E34	4511-5E34		34
4511-2E36	4511-5E36		36
4511-2E38	4511-5E38		38
4511-2E40	4511-5E40		40
4511-2E42	4511-5E42		42
4511-2E44	4511-5E44		44
4511-2E46	4511-5E46		46
4511-2E48	4511-5E48		48
4511-2E50	4511-5E50		50

JHA4.0 4511 |
Cortex Screw HA4.0 (Fully Threaded)
4511-2/5F12~4511-3/5F50



Product No.		Diameter of Screw	Length
Titanium Alloy	Stainless Steel		
4511-2F12	4511-5F12	4.0	12
4511-2F14	4511-5F14		14
4511-2F16	4511-5F16		16
4511-2F18	4511-5F18		18
4511-2F20	4511-5F20		20
4511-2F22	4511-5F22		22
4511-2F24	4511-5F24		24
4511-2F26	4511-5F26		26
4511-2F28	4511-5F28		28
4511-2F30	4511-5F30		30
4511-2F32	4511-5F32		32
4511-2F34	4511-5F34		34
4511-2F36	4511-5F36		36
4511-2F38	4511-5F38		38
4511-2F40	4511-5F40		40
4511-2F42	4511-5F42		42
4511-2F44	4511-5F44		44
4511-2F46	4511-5F46		46
4511-2F48	4511-5F48		48
4511-2F50	4511-5F50		50

JHA4.5 4511 |
Cortex Screw HA4.5 (Fully Threaded)
4511-2/5G20~4511-2/5G60



Product No.		Diameter of Screw	Length
Titanium Alloy	Stainless Steel		
4511-2G20	4511-5G20	4.5	20
4511-2G22	4511-5G22		22
4511-2G24	4511-5G24		24
4511-2G26	4511-5G26		26
4511-2G28	4511-5G28		28
4511-2G30	4511-5G30		30
4511-2G32	4511-5G32		32
4511-2G34	4511-5G34		34
4511-2G36	4511-5G36		36
4511-2G38	4511-5G38		38
4511-2G40	4511-5G40		40
4511-2G42	4511-5G42		42
4511-2G44	4511-5G44		44
4511-2G46	4511-5G46		46
4511-2G48	4511-5G48		48
4511-2G50	4511-5G50		50
4511-2G52	4511-5G52		52
4511-2G54	4511-5G54		54
4511-2G56	4511-5G56		56
4511-2G58	4511-5G58		58
4511-2G60	4511-5G60	60	

JHB3.5 4521 |
Cancellous Screw HB3.5 (Fully Threaded)
4521-2/5E12~4521-2/5E50



Product No.		Diameter of Screw	Length
Titanium Alloy	Stainless Steel		
4521-2E12	4521-5E12	3.5	12
4521-2E14	4521-5E14		14
4521-2E16	4521-5E16		16
4521-2E18	4521-5E18		18
4521-2E20	4521-5E20		20
4521-2E22	4521-5E22		22
4521-2E24	4521-5E24		24
4521-2E26	4521-5E26		26
4521-2E28	4521-5E28		28
4521-2E30	4521-5E30		30
4521-2E32	4521-5E32		32
4521-2E34	4521-5E34		34
4521-2E36	4521-5E36		36
4521-2E38	4521-5E38		38
4521-2E40	4521-5E40		40
4521-2E42	4521-5E42		42
4521-2E44	4521-5E44		44
4521-2E46	4521-5E46		46
4521-2E48	4521-5E48		48
4521-2E50	4521-5E50		50

JHB4.0 4521 |
Cancellous Screw HB4.0 (Fully Threaded)
4521-2/5F14~4521-3/5F60



Product No.		Diameter of Screw	Length
Titanium Alloy	Stainless Steel		
4521-2F14	4521-5F14	4.0	14
4521-2F16	4521-5F16		16
4521-2F18	4521-5F18		18
4521-2F20	4521-5F20		20
4521-2F22	4521-5F22		22
4521-2F24	4521-5F24		24
4521-2F26	4521-5F26		26
4521-2F28	4521-5F28		28
4521-2F30	4521-5F30		30
4521-2F32	4521-5F32		32
4521-2F34	4521-5F34		34
4521-2F36	4521-5F36		36
4521-2F38	4521-5F38		38
4521-2F40	4521-5F40		40
4521-2F42	4521-5F42		42
4521-2F44	4521-5F44		44
4521-2F46	4521-5F46		46
4521-2F48	4521-5F48		48
4521-2F50	4521-5F50		50
4521-2F52	4521-5F52		52
4521-2F54	4521-5F54	54	
4521-2F56	4521-5F56	56	
4521-2F58	4521-5F58	58	
4521-2F60	4521-5F60	60	

JHB4.5 4521 |
Cancellous Screw HB4.5 (Fully Threaded)
4521-2/5G20~4511-2/5G80



Product No.		Diameter of Screw	Length
Titanium Alloy	Stainless Steel		
4521-2G28	4521-5G28	4.5	28
4521-2G30	4521-5G30		30
4521-2G32	4521-5G32		32
4521-2G34	4521-5G34		34
4521-2G36	4521-5G36		36
4521-2G38	4521-5G38		38
4521-2G40	4521-5G40		40
4521-2G42	4521-5G42		42
4521-2G44	4521-5G44		44
4521-2G46	4521-5G46		46
4521-2G48	4521-5G48		48
4521-2G50	4521-5G50		50
4521-2G52	4521-5G52		52
4521-2G54	4521-5G54		54
4521-2G56	4521-5G56		56
4521-2G58	4521-5G58		58
4521-2G60	4521-5G60		60

JHB6.5 4521 |
Cancellous Screw HB6.5 (Fully Threaded)
4521-2/5K35~4521-2/5K110



Product No.		Diameter of Screw	Length
Titanium Alloy	Stainless Steel		
4521-2K35	4521-5K35	6.5	35
4521-2K40	4521-5K40		40
4521-2K45	4521-5K45		45
4521-2K50	4521-5K50		50
4521-2K55	4521-5K55		55
4521-2K60	4521-5K60		60
4521-2K65	4521-5K65		65
4521-2K70	4521-5K70		70
4521-2K75	4521-5K75		75
4521-2K80	4521-5K80		80
4521-2K85	4521-5K85		85
4521-2K90	4521-5K90		90
4521-2K95	4521-5K95		95
4521-2K100	4521-5K100		100
4521-2K105	4521-5K105		105
4521-2K110	4521-5K110		110

JHB3.5 4522 |
Cancellous Screw HB3.5 (Half- Threaded)
4522-2/5E12-4522-3/5E50



Product No.		Diameter of Screw	Length
Titanium Alloy	Stainless Steel		
4522-2E12	4522-5E12	3.5	12
4522-2E14	4522-5E14		14
4522-2E16	4522-5E16		16
4522-2E18	4522-5E18		18
4522-2E20	4522-5E20		20
4522-2E22	4522-5E22		22
4522-2E24	4522-5E24		24
4522-2E26	4522-5E26		26
4522-2E28	4522-5E28		28
4522-2E30	4522-5E30		30
4522-2E32	4522-5E32		32
4522-2E34	4522-5E34		34
4522-2E36	4522-5E36		36
4522-2E38	4522-5E38		38
4522-2E40	4522-5E40		40
4522-2E42	4522-5E42		42
4522-2E44	4522-5E44		44
4522-2E46	4522-5E46		46
4522-2E48	4522-5E48		48
4522-2E50	4522-5E50		50

JHB4.0 4522 |
Cancellous Screw HB4.0 (Half- Threaded)
4522-2/5F16-4522-2/5F60



Product No.		Diameter of Screw	Length
Titanium Alloy	Stainless Steel		
4522-2F16	4522-5F16	4.0	16
4522-2F18	4522-5F18		18
4522-2F20	4522-5F20		20
4522-2F22	4522-5F22		22
4522-2F24	4522-5F24		24
4522-2F26	4522-5F26		26
4522-2F28	4522-5F28		28
4522-2F30	4522-5F30		30
4522-2F32	4522-5F32		32
4522-2F34	4522-5F34		34
4522-2F36	4522-5F36		36
4522-2F38	4522-5F38		38
4522-2F40	4522-5F40		40
4522-2F42	4522-5F42		42
4522-2F44	4522-5F44		44
4522-2F46	4522-5F46		46
4522-2F48	4522-5F48		48
4522-2F50	4522-5F50		50
4522-2F52	4522-5F52		52
4522-2F54	4522-5F54		54
4522-2F56	4522-5F56	56	
4522-2F58	4522-5F58	58	
4522-2F60	4522-5F60	60	

JHB4.5 4522 |
Cancellous Screw HB4.5 (Half- Threaded)
4522-2/5G28-4522-2/5G60



Product No.		Diameter of Screw	Length
Titanium Alloy	Stainless Steel		
4522-2G28	4522-5G28	4.5	28
4522-2G30	4522-5G30		30
4522-2G32	4522-5G32		32
4522-2G34	4522-5G34		34
4522-2G36	4522-5G36		36
4522-2G38	4522-5G38		38
4522-2G40	4522-5G40		40
4522-2G42	4522-5G42		42
4522-2G44	4522-5G44		44
4522-2G46	4522-5G46		46
4522-2G48	4522-5G48		48
4522-2G50	4522-5G50		50
4522-2G52	4522-5G52		52
4522-2G54	4522-5G54		54
4522-2G56	4522-5G56		56
4522-2G58	4522-5G58		58
4522-2G60	4522-5G60		60

JHB6.5 4522 |
Cancellous Screw HB6.5 (Half- Threaded)
4522-2/5K35-4522-3/5K120



Product No.		Diameter of Screw	Length
Titanium Alloy	Stainless Steel		
4522-2K35	4522-5K35	6.5	35
4522-2K40	4522-5K40		40
4522-2K45	4522-5K45		45
4522-2K50	4522-5K50		50
4522-2K55	4522-5K55		55
4522-2K60	4522-5K60		60
4522-2K65	4522-5K65		65
4522-2K70	4522-5K70		70
4522-2K75	4522-5K75		75
4522-2K80	4522-5K80		80
4522-2K85	4522-5K85		85
4522-2K90	4522-5K90		90
4522-2K95	4522-5K95		95
4522-2K100	4522-5K100		100
4522-2K105	4522-5K105		105
4522-2K110	4522-5K110		110
4522-2K115	4522-5K115		115
4522-2K120	4522-5K120		120

JHC2.0 6551 |
Self-Tapping Locking Screws
6551-2/5106-6551-2/5130



Product No.		Diameter of Screw	Length
Titanium Alloy	Stainless Steel		
6551-2106	6551-5106	2.0	6
6551-2108	6551-5108		8
6551-2110	6551-5110		10
6551-2112	6551-5112		12
6551-2114	6551-5114		14
6551-2116	6551-5116		16
6551-2118	6551-5118		18
6551-2120	6551-5120		20
6551-2122	6551-5122		22
6551-2124	6551-5124		24
6551-2126	6551-5126		26
6551-2128	6551-5128		28
6551-2130	6551-5130		30

JHC2.5 6531 |
Self-Tapping Locking Screws
6531-2/5110-4521-2/5130



Product No.		Diameter of Screw	Length
Titanium Alloy	Stainless Steel		
6531-2110	6531-5110	2.5	10
6531-2112	6531-5112		12
6531-2114	6531-5114		14
6531-2116	6531-5116		16
6531-2118	6531-5118		18
6531-2120	6531-5120		20
6531-2122	6531-5122		22
6531-2124	6531-5124		24
6531-2126	6531-5126		26
6531-2128	6531-5128		28
6531-2130	6531-5130		30

JHC3.5 6511 |
Self-Tapping Locking Screws
6511-2/5110-6511-3/5160



Product No.		Diameter of Screw	Length
Titanium Alloy	Stainless Steel		
6511-2110	6511-5110	3.5	10
6511-2112	6511-5112		12
6511-2114	6511-5114		14
6511-2116	6511-5116		16
6511-2118	6511-5118		18
6511-2120	6511-5120		20
6511-2122	6511-5122		22
6511-2124	6511-5124		24
6511-2126	6511-5126		26
6511-2128	6511-5128		28
6511-2130	6511-5130		30
6511-2132	6511-5132		32
6511-2134	6511-5134		34
6511-2136	6511-5136		36
6511-2138	6511-5138		38
6511-2140	6511-5140		40
6511-2142	6511-5142		42
6511-2144	6511-5144		44
6511-2146	6511-5146		46
6511-2148	6511-5148		48
6511-2150	6511-5150	50	
6511-2155	6511-5155	55	
6511-2160	6511-5160	60	

JHC3.5 6516 |
Self-Tapping Locking Screws
6516-2/5110-6516-3/5160



Product No.		Diameter of Screw	Length
Titanium Alloy	Stainless Steel		
6516-2110	6516-5110	3.5	10
6516-2112	6516-5112		12
6516-2114	6516-5114		14
6516-2116	6516-5116		16
6516-2118	6516-5118		18
6516-2120	6516-5120		20
6516-2122	6516-5122		22
6516-2124	6516-5124		24
6516-2126	6516-5126		26
6516-2128	6516-5128		28
6516-2130	6516-5130		30
6516-2132	6516-5132		32
6516-2134	6516-5134		34
6516-2136	6516-5136		36
6516-2138	6516-5138		38
6516-2140	6516-5140		40
6516-2142	6516-5142		42
6516-2144	6516-5144		44
6516-2146	6516-5146		46
6516-2148	6516-5148		48
6516-2150	6516-5150	50	
6516-2155	6516-5155	55	
6516-2160	6516-5160	60	

JHC5.0 6512 |
Self-Tapping Locking Screws
6512-2/5114-6512-2/5110



Product No.		Diameter of Screw	Length
Titanium Alloy	Stainless Steel		
6512-2114	6512-5114	5.0	14
6512-2116	6512-5116		16
6512-2118	6512-5118		18
6512-2120	6512-5120		20
6512-2122	6512-5122		22
6512-2124	6512-5124		24
6512-2126	6512-5126		26
6512-2128	6512-5128		28
6512-2130	6512-5130		30
6512-2132	6512-5132		32
6512-2134	6512-5134		34
6512-2136	6512-5136		36
6512-2138	6512-5138		38
6512-2140	6512-5140		40
6512-2142	6512-5142		42
6512-2144	6512-5144		44
6512-2146	6512-5146		46
6512-2148	6512-5148		48
6512-2150	6512-5150		50
6512-2155	6512-5155		55
6512-2160	6512-5160	60	
6512-2165	6512-5165	65	
6512-2170	6512-5170	70	
6512-2175	6512-5175	75	
6512-2180	6512-5180	80	
6512-2185	6512-5185	85	
6512-2190	6512-5190	90	
6512-2195	6512-5195	95	
6512-2110	6512-5110	100	

JHC5.0 6515 |
Self-Tapping Locking Screws
6515-2/5114-6515-2/5110



Product No.		Diameter of Screw	Length
Titanium Alloy	Stainless Steel		
6515-2114	6515-5114	5.0	14
6515-2116	6515-5116		16
6515-2118	6515-5118		18
6515-2120	6515-5120		20
6515-2122	6515-5122		22
6515-2124	6515-5124		24
6515-2126	6515-5126		26
6515-2128	6515-5128		28
6515-2130	6515-5130		30
6515-2132	6515-5132		32
6515-2134	6515-5134		34
6515-2136	6515-5136		36
6515-2138	6515-5138		38
6515-2140	6515-5140		40
6515-2142	6515-5142		42
6515-2144	6515-5144		44
6515-2146	6515-5146		46
6515-2148	6515-5148		48
6515-2150	6515-5150		50
6515-2155	6515-5155		55
6515-2160	6515-5160	60	
6515-2165	6515-5165	65	
6515-2170	6515-5170	70	
6515-2175	6515-5175	75	
6515-2180	6515-5180	80	
6515-2185	6515-5185	85	
6515-2190	6515-5190	90	
6515-2195	6515-5195	95	
6515-2110	6515-5110	100	

JHC6.5 6541 |
Self-Tapping Locking Screws
6541-2/5050-6541-2/5120



Product No.		Diameter of Screw	Length
Titanium Alloy	Stainless Steel		
6541-2050	6541-5050	6.5	50
6541-2055	6541-5055		55
6541-2060	6541-5060		60
6541-2065	6541-5065		65
6541-2070	6541-5070		70
6541-2075	6541-5075		75
6541-2080	6541-5080		80
6541-2085	6541-5085		85
6541-2090	6541-5090		90
6541-2095	6541-5095		95
6541-2100	6541-5100		100
6541-2105	6541-5105		105
6541-2110	6541-5110		110
6541-2115	6541-5115		115
6541-2120	6541-5120		120

JHC6.5 6542 |
Self-Tapping Locking Screws
6542-2/5050-6542-2/5120



Product No.		Diameter of Screw	Length
Titanium Alloy	Stainless Steel		
6542-2050	6542-5050	6.5	50
6542-2055	6542-5055		55
6542-2060	6542-5060		60
6542-2065	6542-5065		65
6542-2070	6542-5070		70
6542-2075	6542-5075		75
6542-2080	6542-5080		80
6542-2085	6542-5085		85
6542-2090	6542-5090		90
6542-2095	6542-5095		95
6542-2100	6542-5100		100
6542-2105	6542-5105		105
6542-2110	6542-5110		110
6542-2115	6542-5115		115
6542-2120	6542-5120		120

JHC6.5 6545 |
Self-Tapping Locking Screws
6545-2/5050-6545-2/5120



Product No.		Diameter of Screw	Length
Titanium Alloy	Stainless Steel		
6545-2050	6545-5050	6.5	50
6545-2055	6545-5055		55
6545-2060	6545-5060		60
6545-2065	6545-5065		65
6545-2070	6545-5070		70
6545-2075	6545-5075		75
6545-2080	6545-5080		80
6545-2085	6545-5085		85
6545-2090	6545-5090		90
6545-2095	6545-5095		95
6545-2100	6545-5100		100
6545-2105	6545-5105		105
6545-2110	6545-5110		110
6545-2115	6545-5115		115
6545-2120	6545-5120		120

JHC6.5 6544 |
Self-Tapping Locking Screws
6544-2/5050-6544-2/5120



Product No.		Diameter of Screw	Length
Titanium Alloy	Stainless Steel		
6544-2050	6544-5050	6.5	50
6544-2055	6544-5055		55
6544-2060	6544-5060		60
6544-2065	6544-5065		65
6544-2070	6544-5070		70
6544-2075	6544-5075		75
6544-2080	6544-5080		80
6544-2085	6544-5085		85
6544-2090	6544-5090		90
6544-2095	6544-5095		95
6544-2100	6544-5100		100
6544-2105	6544-5105		105
6544-2110	6544-5110		110
6544-2115	6544-5115		115
6544-2120	6544-5120		120

JHC3.5 6521 |
Self-Drilling Locking Screws
6521-2/5112-6521-2/5160



Product No.		Diameter of Screw	Length
Titanium Alloy	Stainless Steel		
6521-2112	6521-5112	3.5	12
6521-2114	6521-5114		14
6521-2116	6521-5116		16
6521-2118	6521-5118		18
6521-2120	6521-5120		20
6521-2122	6521-5122		22
6521-2124	6521-5124		24
6521-2126	6521-5126		26
6521-2128	6521-5128		28
6521-2130	6521-5130		30
6521-2135	6521-5135		35
6521-2140	6521-5140		40
6521-2145	6521-5145		45
6521-2150	6521-5150		50
6521-2155	6521-5155		55
6521-2160	6521-5160		60

JHC5.0 6522 |
Self-Drilling Locking Screws
6521-2/5114-6521-2/5110



Product No.		Diameter of Screw	Length
Titanium Alloy	Stainless Steel		
6522-2114	6522-5114	5.0	14
6522-2116	6522-5116		16
6522-2118	6522-5118		18
6522-2120	6522-5120		20
6522-2122	6522-5122		22
6522-2124	6522-5124		24
6522-2126	6522-5126		26
6522-2128	6522-5128		28
6522-2130	6522-5130		30
6522-2132	6522-5132		32
6522-2134	6522-5134		34
6522-2136	6522-5136		36
6522-2138	6522-5138		38
6522-2140	6522-5140		40
6522-2142	6522-5142		42
6522-2144	6522-5144		44
6522-2146	6522-5146		46
6522-2148	6522-5148		48
6522-2150	6522-5150		50
6522-2155	6522-5155		55
6522-2160	6522-5160		60
6522-2165	6522-5165	65	
6522-2170	6522-5170	70	
6522-2175	6522-5175	75	
6522-2180	6522-5180	80	
6522-2185	6522-5185	85	
6522-2190	6522-5190	90	
6522-2195	6522-5195	95	
6522-2110	6522-5110	100	

4225 | Rib Plate
4225-2/5050~4225-2/5120



Product No.	Width	Length
Pure Titanium		
4225-3130	13	30
4225-3145	13	45
4225-3155	13	55
4225-3230	16	30
4225-3245	16	45
4225-3255	16	55
4225-3330	20	30
4225-3345	20	45
4225-3355	20	55

Double-Head Cannulated Screws

- Φ 2.0 4557-2/5012~4558-2/5050
- Φ 2.5 4555-2/5014~4556-2/5050
- Φ 3.0 4542-2/5016~4544-2/5040



Product No.		Diameter of Screw	Length	Length of Thread
Titanium Alloy	Stainless Steel			
4557-2012	4557-5012	2.0	12	6
4557-2014	4557-5014		14	6
4557-2016	4557-5016		16	6
4557-2018	4557-5018		18	6
4557-2020	4557-5020		20	6
4557-2022	4557-5022		22	7
4557-2024	4557-5024		24	7
4557-2026	4557-5026		26	7
4557-2028	4557-5028		28	7
4557-2030	4557-5030		30	7
4557-2032	4557-5032	32	7	
4557-2034	4557-5034	34	7	
4557-2036	4557-5036	36	7	
4557-2038	4557-5038	38	7	
4557-2040	4557-5040	40	7	
4558-2026	4558-5026	2.0	26	10
4558-2028	4558-5028		28	10
4558-2030	4558-5030		30	10
4558-2032	4558-5032		32	10
4558-2034	4558-5034		34	10
4558-2036	4558-5036		36	10
4558-2038	4558-5038		38	10
4558-2040	4558-5040		40	10
4558-2042	4558-5042		42	10
4558-2044	4558-5044		44	10
4558-2046	4558-5046	46	10	
4558-2048	4558-5048	48	10	
4558-2050	4558-5050	50	10	
4555-2014	4555-5014	2.5	14	6
4555-2016	4555-5016		16	6
4555-2018	4555-5018		18	6
4555-2020	4555-5020		20	6
4555-2022	4555-5022		22	7
4555-2024	4555-5024		24	7
4555-2026	4555-5026		26	7
4555-2028	4555-5028		28	7
4555-2030	4555-5030		30	7
4555-2032	4555-5032		32	7
4555-2034	4555-5034	34	7	
4555-2036	4555-5036	36	7	
4555-2038	4555-5038	38	7	
4555-2040	4555-5040	40	7	
4556-2026	4556-5026	2.5	26	12
4556-2028	4556-5028		28	12
4556-2030	4556-5030		30	12
4556-2032	4556-5032		32	12
4556-2034	4556-5034		34	12
4556-2036	4556-5036		36	12
4556-2038	4556-5038		38	12
4556-2040	4556-5040		40	12
4556-2042	4556-5042		42	12
4556-2044	4556-5044		44	12
4556-2046	4556-5046	46	12	
4556-2048	4556-5048	48	12	
4556-2050	4556-5050	50	12	
4542-2016	4542-5016	3.0	16	5
4542-2018	4542-5018		18	6
4542-2020	4542-5020		20	7
4542-2022	4542-5022		22	8
4542-2024	4542-5024		24	8
4542-2026	4542-5026		26	10
4542-2028	4542-5028		28	10
4542-2030	4542-5030		30	12
4542-2032	4542-5032		32	12
4542-2034	4542-5034		34	14
4542-2036	4542-5036	36	14	
4542-2038	4542-5038	38	16	
4542-2040	4542-5040	40	16	
4544-2010	4544-5010	3.0	10	4
4544-2012	4544-5012		12	4
4544-2014	4544-5014		14	4
4544-2016	4544-5016		16	4
4544-2018	4544-5018		18	4
4544-2020	4544-5020		20	4
4544-2022	4544-5022		22	4
4544-2024	4544-5024		24	5
4544-2026	4544-5026		26	5
4544-2028	4544-5028		28	6
4544-2030	4544-5030	30	7	
4544-2032	4544-5032	32	7	
4544-2034	4544-5034	34	8	
4544-2036	4544-5036	36	9	
4544-2038	4544-5038	38	9	
4544-2040	4544-5040	40	10	

T4225 | Rib Plate Instrument

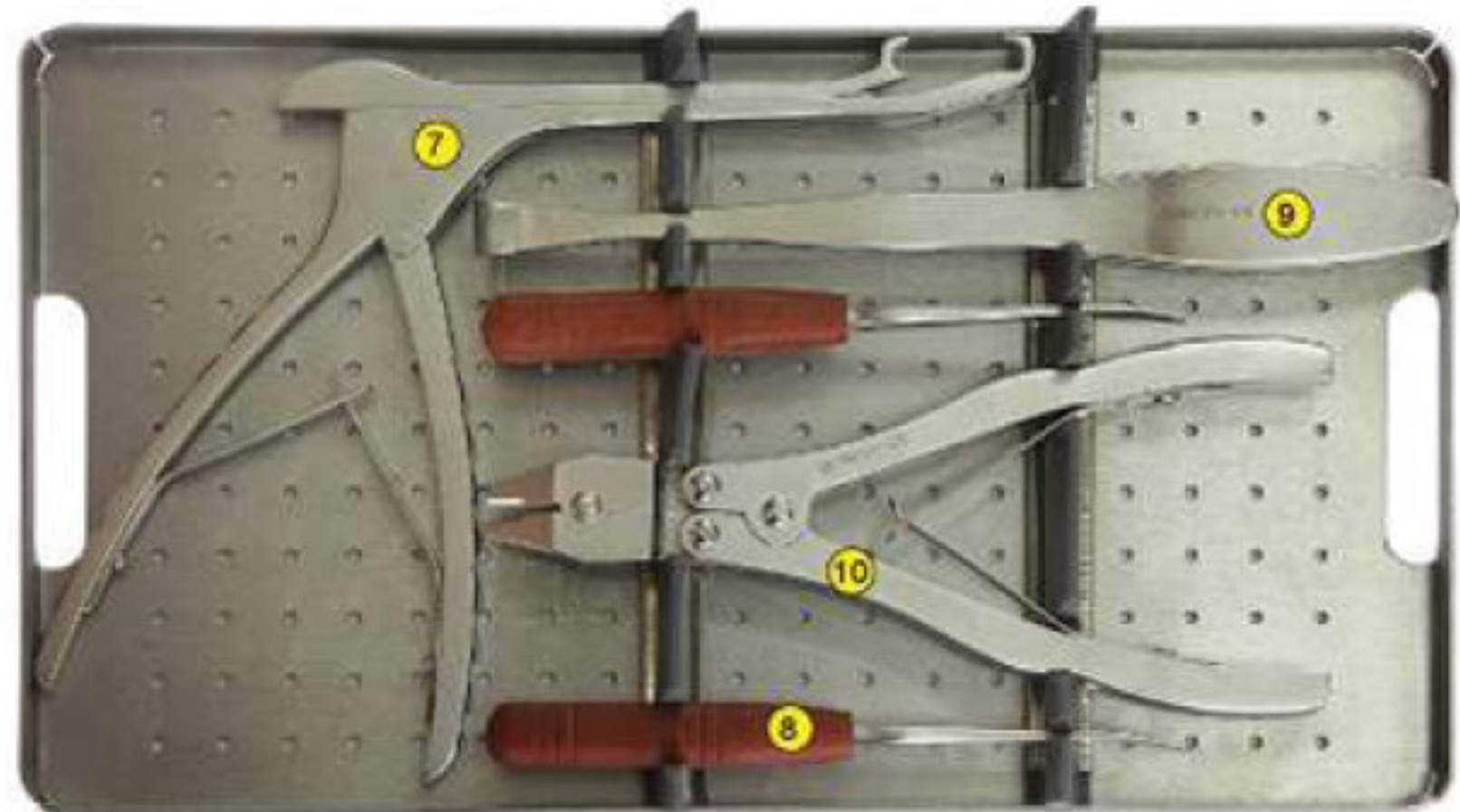
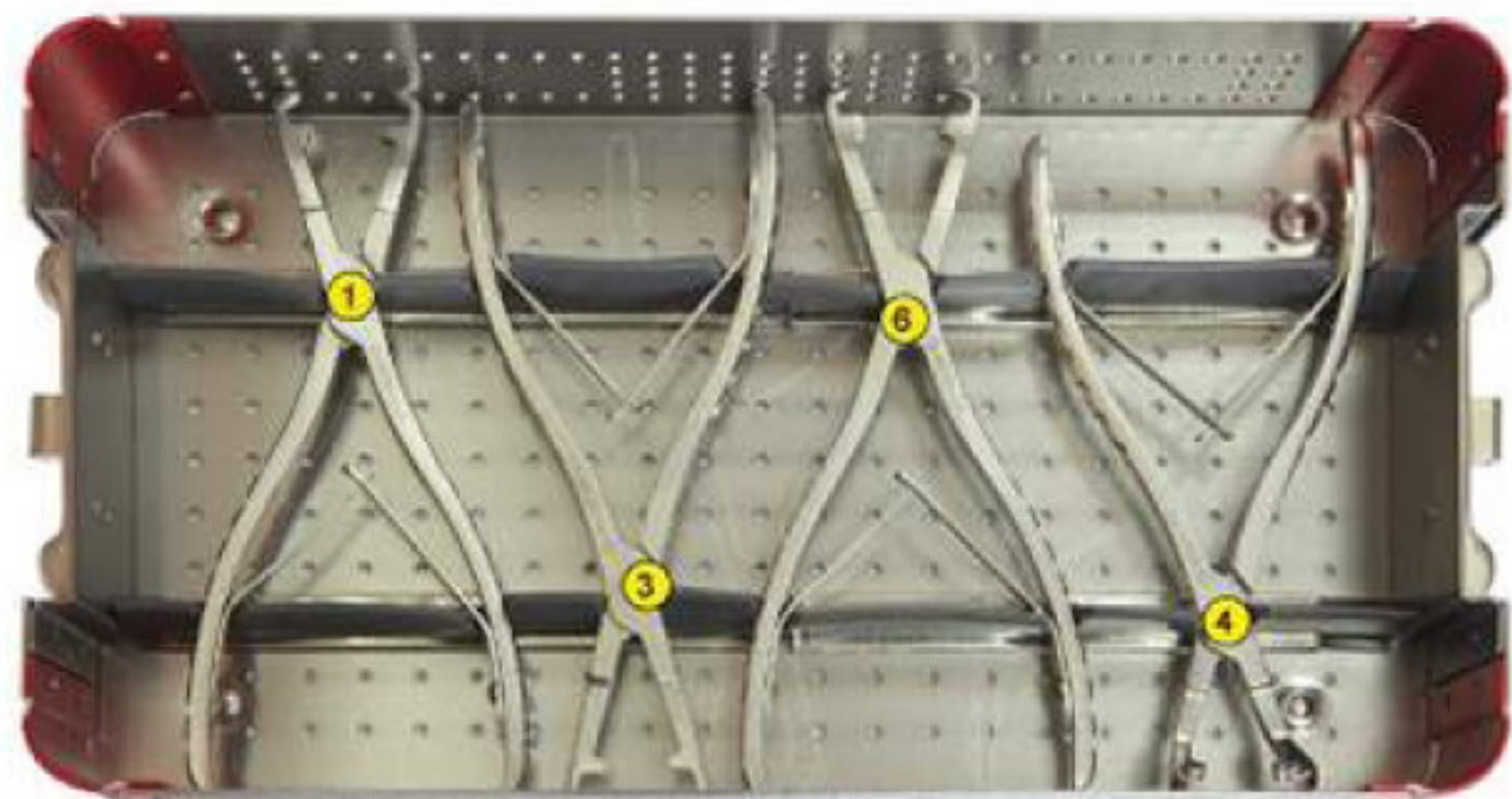

Product No.	Product Name
T4225-0001	straight forcing forcep (L)
T4225-0002	straight forcing forcep (S)
T4225-0003	unilateral forcing forceps
T4225-0004	Curve forcing forcep (L)
T4225-0005	Curve forcing forcep (S)
T4225-0006	backside special forcing forcep
T4225-0007	Rib special Forcing forcep Under shoulder blade
T4225-0008	Periosteal Detacher (S)
T4225-0009	Periosteal Detacher (L)
T4225-0010	Plate Cutting Forcep

Cannulated Compression Screws

Φ 3.5 4530-2/5020-4530-2/5050

Φ 4.0 4538-2/5020-4538-2/5060

Φ 4.5 4531-2/5026-4531-2/5070

Φ 6.5 4534-2/5050-4534-2/5120

Φ 7.3 4532-2/5050-4532-2/5120



Cannulated Compression Screws Shim

4530-2/5001-4532-2/5001



Product No.		Diameter of Screw	Length
Titanium Alloy	Stainless Steel		
4530-2020	4530-5020	3.5	20
4530-2022	4530-5022		22
4530-2024	4530-5024		24
4530-2026	4530-5026		26
4530-2028	4530-5028		28
4530-2030	4530-5030		30
4530-2032	4530-5032		32
4530-2034	4530-5034		34
4530-2036	4530-5036		36
4530-2038	4530-5038		38
4530-2040	4530-5040		40
4530-2042	4530-5042		42
4530-2044	4530-5044		44
4530-2046	4530-5046		46
4530-2048	4530-5048		48
4530-2050	4530-5050	50	

Product No.		Diameter of Screw	Length	
Titanium Alloy	Stainless Steel			
4538-2020	4538-5020	4.0	20	
4538-2022	4538-5022		22	
4538-2024	4538-5024		24	
4538-2026	4538-5026		26	
4538-2028	4538-5028		28	
4538-2030	4538-5030		30	
4538-2032	4538-5032		32	
4538-2034	4538-5034		34	
4538-2036	4538-5036		36	
4538-2038	4538-5038		38	
4538-2040	4530-5040		40	
4538-2042	4538-5042		42	
4538-2044	4538-5044		44	
4538-2046	4538-5046		46	
4538-2048	4538-5048		48	
4538-2050	4538-5050		50	
4538-2052	4538-5052		52	
4538-2054	4538-5054		54	
4538-2056	4538-5056		56	
4538-2058	4538-5058		58	
4538-2060	4538-5060		60	
4531-2026	4531-5026		4.5	26
4531-2028	4531-5028			28
4531-2030	4531-5030			30
4531-2032	4531-5032			32
4531-2034	4531-5034	34		
4531-2035	4531-5035	35		
4531-2036	4531-5036	36		
4531-2038	4531-5038	38		
4531-2040	4531-5040	40		
4531-2042	4531-5042	42		
4531-2044	4531-5044	44		
4531-2045	4531-5045	45		
4531-2046	4531-5046	46		
4531-2048	4531-5048	48		
4531-2050	4531-5050	50		
4531-2052	4531-5052	52		
4531-2054	4531-5054	54		
4531-2055	4531-5055	55		
4531-2056	4531-5056	56		
4531-2058	4531-5058	58		
4531-2060	4531-5060	60		
4531-2062	4531-5062	62		
4531-2064	4531-5064	64		
4531-2065	4531-5065	65		
4531-2066	4531-5066	66		
4531-2068	4531-5068	68		
4531-2070	4531-5070	70		
4534-2050	4534-5050	6.5	50	
4534-2055	4534-5055		55	
4534-2060	4534-5060		60	
4534-2065	4534-5065		65	
4534-2070	4534-5070		70	
4534-2075	4534-5075		75	
4534-2080	4534-5080		80	
4534-2085	4534-5085		85	
4534-2090	4534-5090		90	
4534-2095	4534-5095		95	
4534-2100	4534-5100		100	
4534-2105	4534-5105		105	
4534-2110	4534-5110		110	
4534-2115	4534-5115		115	
4534-2120	4534-5120		120	
4532-2050	4532-5050	7.3	50	
4532-2055	4532-5055		55	
4532-2060	4532-5060		60	
4532-2065	4532-5065		65	
4532-2070	4532-5070		70	
4532-2075	4532-5075		75	
4532-2080	4532-5080		80	
4532-2085	4532-5085		85	
4532-2090	4532-5090		90	
4532-2095	4532-5095		95	
4532-2100	4532-5100		100	
4532-2105	4532-5105		105	
4532-2110	4532-5110		110	
4532-2115	4532-5115		115	
4532-2120	4532-5120		120	
4530-2001	4530-5001	3.5	shim	
4531-2001	4531-5001	4.5	shim	
4534-2001	4534-5001	6.5	shim	
4532-2001	4532-5001	7.3	shim	

4541 | Double-Head Cannulated Screws

4541-2/5060-4541-2/5110



4610 | Intramedullary Pin (Kirschner Wire)

4611-2/5004-4628-2/5025



4546 | Cannulated Compression Screws

4546-2/5014-4546-2/5050



Product No.		Diameter of Screw	Length
Titanium Alloy	Stainless Steel		
4541-2060	4541-5060	6.0	60
4541-2065	4541-5065		65
4541-2070	4541-5070		70
4541-2075	4541-5075		75
4541-2080	4541-5080		80
4541-2085	4541-5085		85
4541-2090	4541-5090		90
4541-2095	4541-5095		95
4541-2100	4541-5100		100
4541-2105	4541-5105		105
4541-2110	4541-5110		110

Product No.		Diameter of Screw	Length
Titanium Alloy	Stainless Steel		
4611-2004 ~ 28	4611-5004 ~ 28	0.8	40 ~ 280
4612-2004 ~ 28	4612-5004 ~ 28	1.0	40 ~ 280
4613-2004 ~ 28	4613-5004 ~ 28	1.2	40 ~ 280
4614-2004 ~ 28	4614-5004 ~ 28	1.5	40 ~ 280
4615-2010 ~ 30	4615-5010 ~ 30	2.0	100 ~ 300
4616-2015 ~ 30	4616-5015 ~ 30	2.5	150 ~ 300
4617-2020 ~ 30	4617-5020 ~ 30	3.0	200 ~ 300
4618-2020 ~ 30	4618-5020 ~ 30	3.5	200 ~ 300
4619-2020 ~ 30	4619-5020 ~ 30	4.0	200 ~ 300
4620-2020 ~ 30	4620-5020 ~ 30	4.5	200 ~ 300
4621-2020 ~ 30	4621-5020 ~ 30	5.0	200 ~ 300
4624-2008 ~ 25	4624-5008 ~ 25	2.0	80 ~ 250
4625-2008 ~ 25	4625-5008 ~ 25	2.5	80 ~ 250
4626-2008 ~ 25	4626-5008 ~ 25	1.0	80 ~ 250
4627-2008 ~ 25	4627-5008 ~ 25	1.2	80 ~ 250
4628-2008 ~ 25	4628-5008 ~ 25	1.5	80 ~ 250

Product No.		Diameter of Screw	Length	
Titanium Alloy	Stainless Steel			
4546-2014	4546-5014	2.4	14	
4546-2016	4546-5016		16	
4546-2018	4546-5018		18	
4546-2020	4546-5020		20	
4546-2022	4546-5022		22	
4546-2024	4546-5024		24	
4546-2026	4546-5026		26	
4546-2028	4546-5028		28	
4546-2030	4546-5030		30	
4546-2035	4546-5035		35	
4546-2040	4546-5040		40	
4546-2045	4546-5045		45	
4546-2050	4546-5050		50	
4547-2014	4547-5014		4.0	14
4547-2016	4547-5016			16
4547-2018	4547-5018	18		
4547-2020	4547-5020	20		
4547-2022	4547-5022	22		
4547-2024	4547-5024	24		
4547-2026	4547-5026	26		
4547-2028	4547-5028	28		
4547-2030	4547-5030	30		
4547-2035	4547-5035	35		
4547-2040	4547-5040	40		
4547-2045	4547-5045	45		
4547-2050	4547-5050	50		

T4531
Φ4.5 Cannulated Screw Instrument Case



Product No.	Product Name	
T4531-0100		Cannulated Hex Screwdriver
T4531-0200		Hexagonal Screwdriver
T4531-0300		Countersink Drill
T4531-0400	HA4.5	Screw Tap HA4.5
T4531-0500		Screw Anti-skidding Extractor
T4531-0600	Φ 1.2*150	Guide Wire Depth Gauge
T4531-0700		Cannulated Drill Bit
T4531-0800	SW2.5	Stop Drill Wrench
T4531-0900		Guide Wire Sleeve
T4531-1000		Drill Guide
T4531-1100		Threaded Guide Pin
T4531-1200		Pin
T4531-1300		Guide Wrench
T4531-1400	Φ 1.2*200	Cleaning Stylet

T4532
Φ7.3 Cannulated Screw Instrument Case

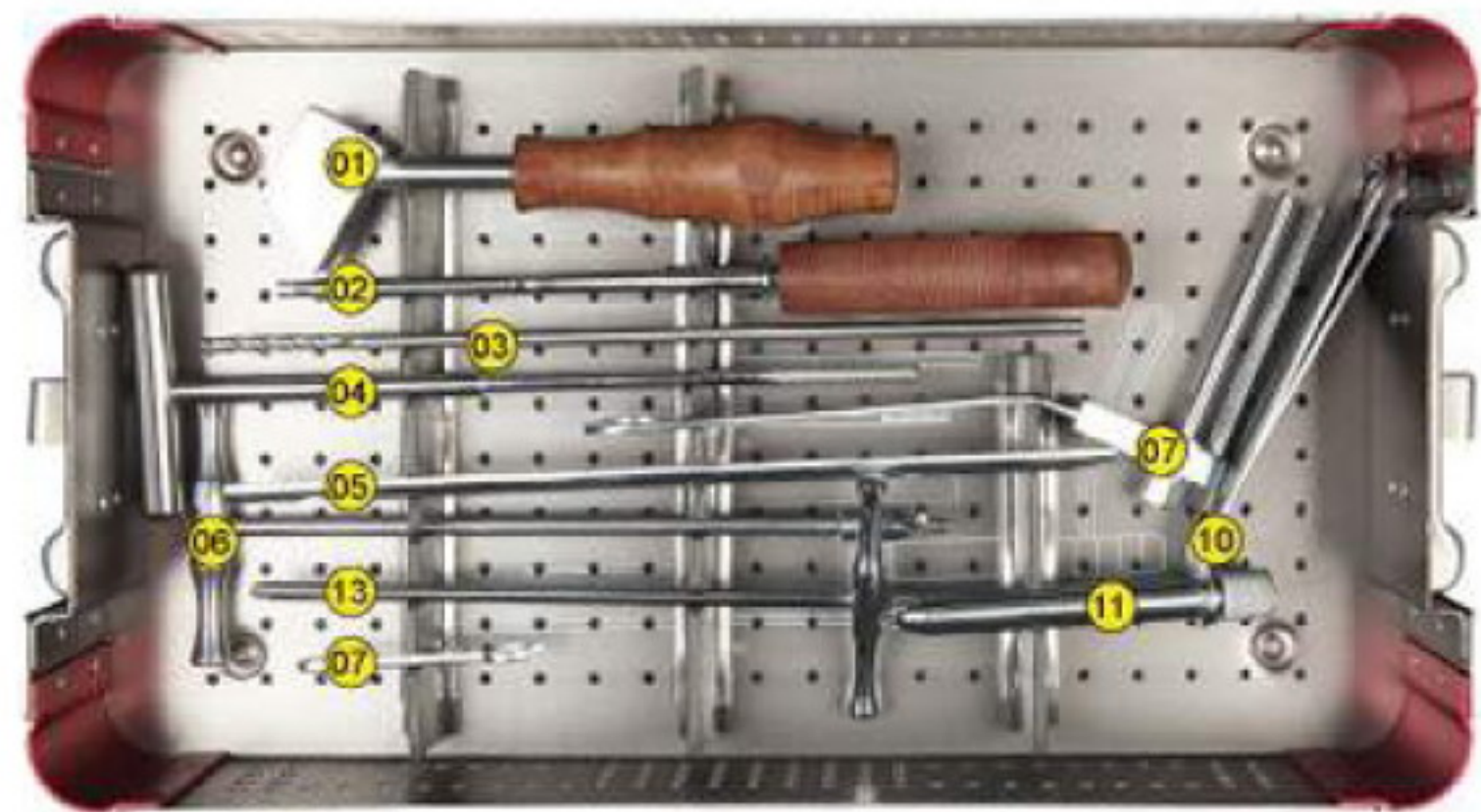
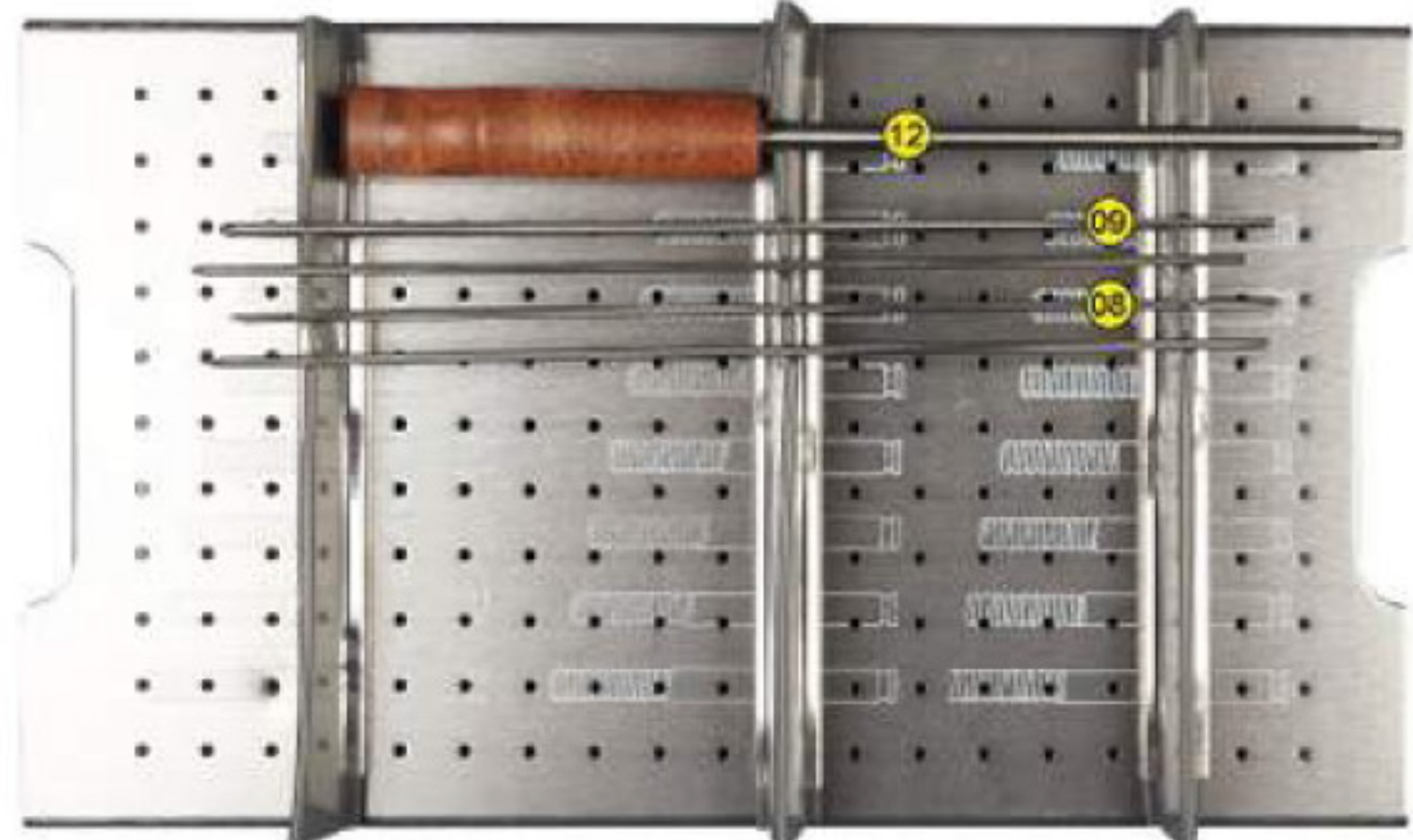

Product No.	Product Name	
T4532-0100		Drill Guide
T4532-0200		Screw Driver, Cannulated SW4
T4532-0300	Φ 5/Φ 2.5*250	Drill Cannulated
T4532-0400	Φ 7.3/Φ 2.5 P=2.75	Screw Tap ,CannulatedΦ7.3
T4532-0500	2.5*250	Measuring device
T4532-0600		Countersink Drill, Cannulated
T4532-0700	Φ 2.5	Double Hole Drill Guide
T4532-0701		Double Hole Drill Guide Wrench
T4532-0800	Φ 2.5*250	Guide Pin Φ 2.5*250
T4532-0900	Φ 2.5*250	Threaded Guide Pin
T4532-1000	Φ 2.5	Expander
T4532-1100	Φ 5	Drill Sleeve
T4532-1200	SW4.0	Hex Screw Driver SW4.0
T4532-1300	SW4	Screw Anti-skidding Extractor

T4551
Φ3.0 Double-Head Cannulated Screw Instrument Case

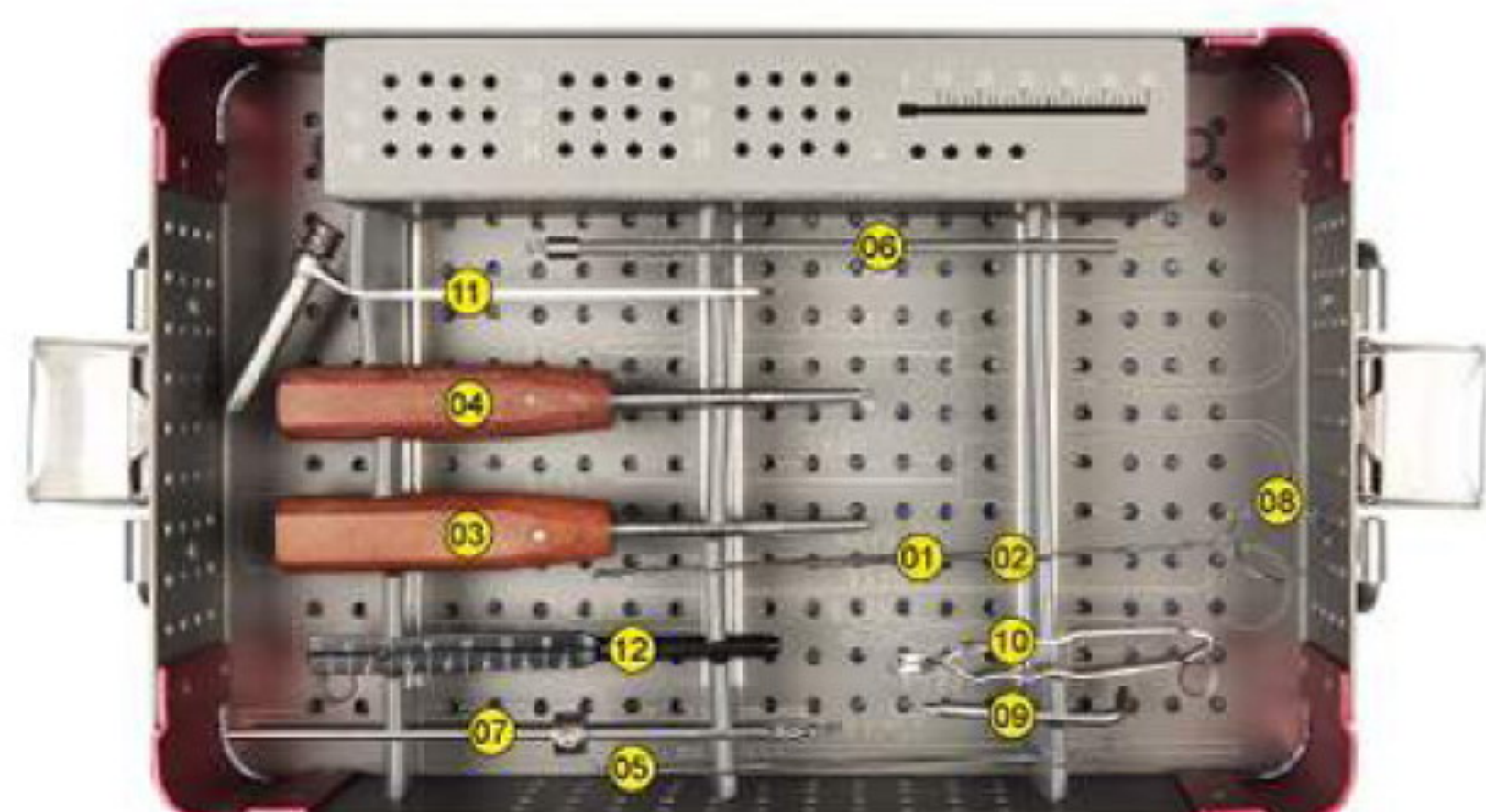

Product No.	Product Name	
T4551-0100	Φ 1.0*120	Guide Pin
T4551-0200	Φ 1.0*121	Threaded Guide Pin
T4551-0300	2.5	Star Screwdriver 2.5
T4551-0400	2.5	Cannulated Star Screwdriver 2.5
T4551-0500	Φ 2/Φ 2.4/Φ 2.8*5.5 Φ 1.0	Cannulated Drill Bit Φ 2*5.5
T4551-0600	Φ 3*5	Cannulated Spot-facer
T4551-0700	Φ 2*9/Φ 2.4/Φ 2.8 Φ 1.0	Drill CannulatedΦ 2*9
T4551-0800	Φ 1.0*150	Guide Pin For Cleaning
T4551-0900	SW2.5	Stop Drill Wrench
T4551-1000		Screw Holding Forceps
T4551-1100	Φ 2.8	Guide Wire Drill Sleeve
T4551-1200	Φ 1.0*120	Measuring Device

(DHG) 3610 | Cannulated Humeral Nails



Product No.		Diameter of Nails	Length
Titanium Alloy	Stainless Steel		
3611-2018	3611-5018	7	180
3611-2020	3611-5020		200
3611-2022	3611-5022		220
3611-2024	3611-5024		240
3611-2026	3611-5026		260
3611-2028	3611-5028		280
3611-2030	3611-5030	8	300
3612-2018	3612-5018		180
3612-2020	3612-5020		200
3612-2022	3612-5022		220
3612-2024	3612-5024		240
3612-2026	3612-5026		260
3612-2028	3612-5028	280	
3612-2030	3612-5030	300	
3613-2018	3613-5018	9	180
3613-2020	3613-5020		200
3613-2022	3613-5022		220
3613-2024	3613-5024		240
3613-2026	3613-5026		260
3613-2028	3613-5028		280
3613-2030	3613-5030	300	

(DHG) | Cannulated Humeral Nails

3611-2/5018-3613-2/5030



3620 | Locking Screws

3620-2/5G18-3620-2/5G50



Product No.		Diameter of Screw	Length
Titanium Alloy	Stainless Steel		
3620-2G18	3620-5G18	3.5	17.5
3620-2G20	3620-5G20		20
3620-2G22	3620-5G22		22.5
3620-2G25	3620-5G25		25
3620-2G28	3620-5G28		28
3620-2G30	3620-5G30		30
3620-2G32	3620-5G32		32.5
3620-2G35	3620-5G35		35
3620-2G37	3620-5G37		37.5
3620-2G40	3620-5G40		40
3620-2G45	3620-5G45		45
3620-2G50	3620-5G50		50

INTERLOCKING NAIL SERIES

3710 | Humeral Self-locking Nails (DZH)



3711-5019~3713-5030

Humeral Self-locking Nails (DZH)



Product No.	Diameter of Nails	Length	Material
3711-5019	7	190	Stainless Steel
3711-5020		200	
3711-5021		210	
3711-5022		220	
3711-5023		230	
3711-5024		240	
3711-5025		250	
3711-5026		260	
3711-5027		270	
3711-5028		280	
3711-5029	290		
3711-5030	300		
3712-5019	8	190	
3712-5020		200	
3712-5021		210	
3712-5022		220	
3712-5023		230	
3712-5024		240	
3712-5025		250	
3712-5026		260	
3712-5027		270	
3712-5028		280	
3712-5029	290		
3712-5030	300		
3713-5019	9	190	
3713-5020		200	
3713-5021		210	
3713-5022		220	
3713-5023		230	
3713-5024		240	
3713-5025		250	
3713-5026		260	
3713-5027		270	
3713-5028		280	
3713-5029	290		
3713-5030	300		

T3 3720 | Locking Screws

3720-5F20~3720-5F50



Product No.	Diameter of Screw	Length	Material
3720-5F20	HA4	20	Stainless Steel
3720-5F25		25	
3720-5F30		30	
3720-5F35		35	
3720-5F40		40	
3720-5F45		45	
3720-5F50		50	

INTERLOCKING NAIL SERIES

T3610
Cannulated Interlocking Nail Instrument

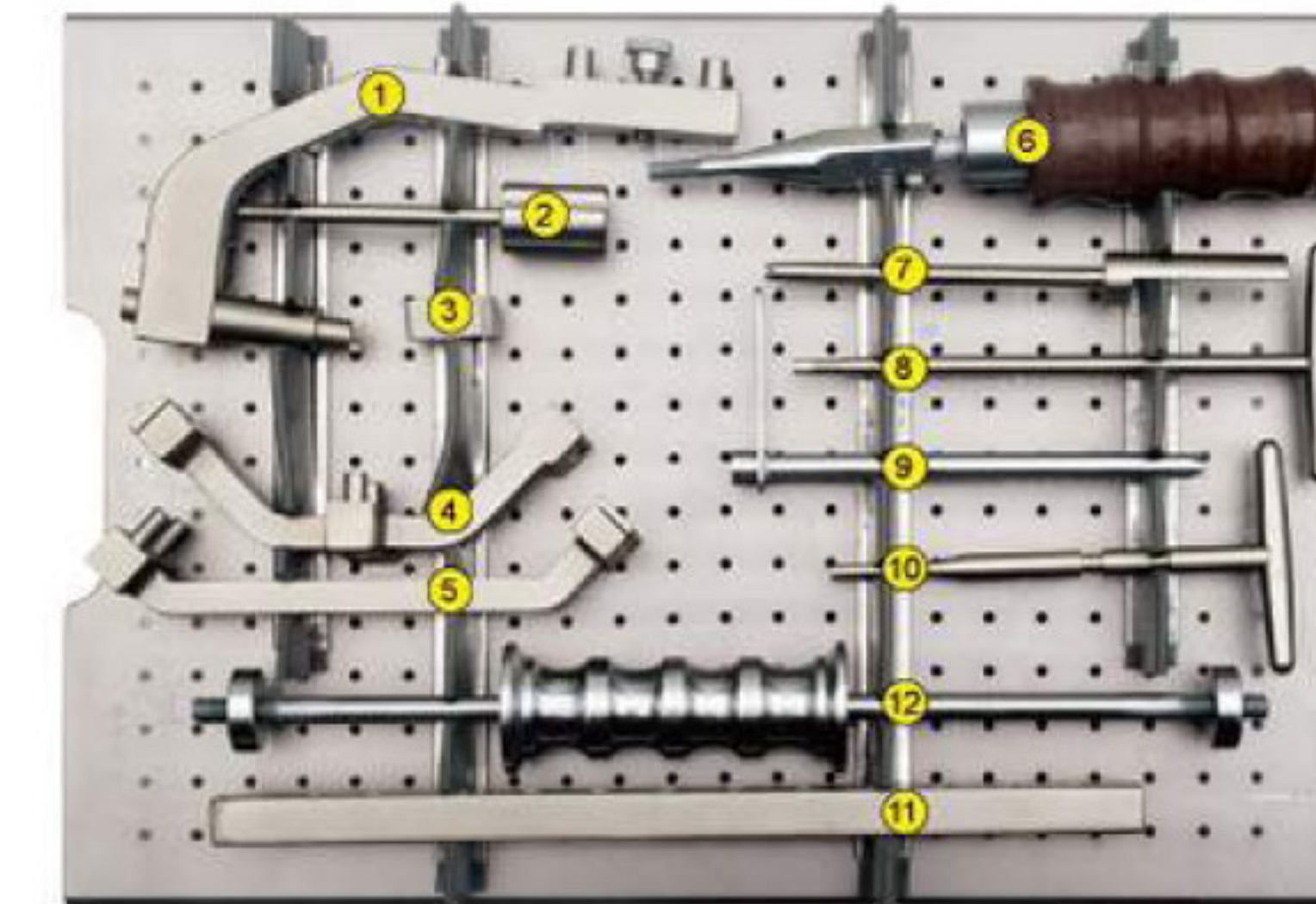
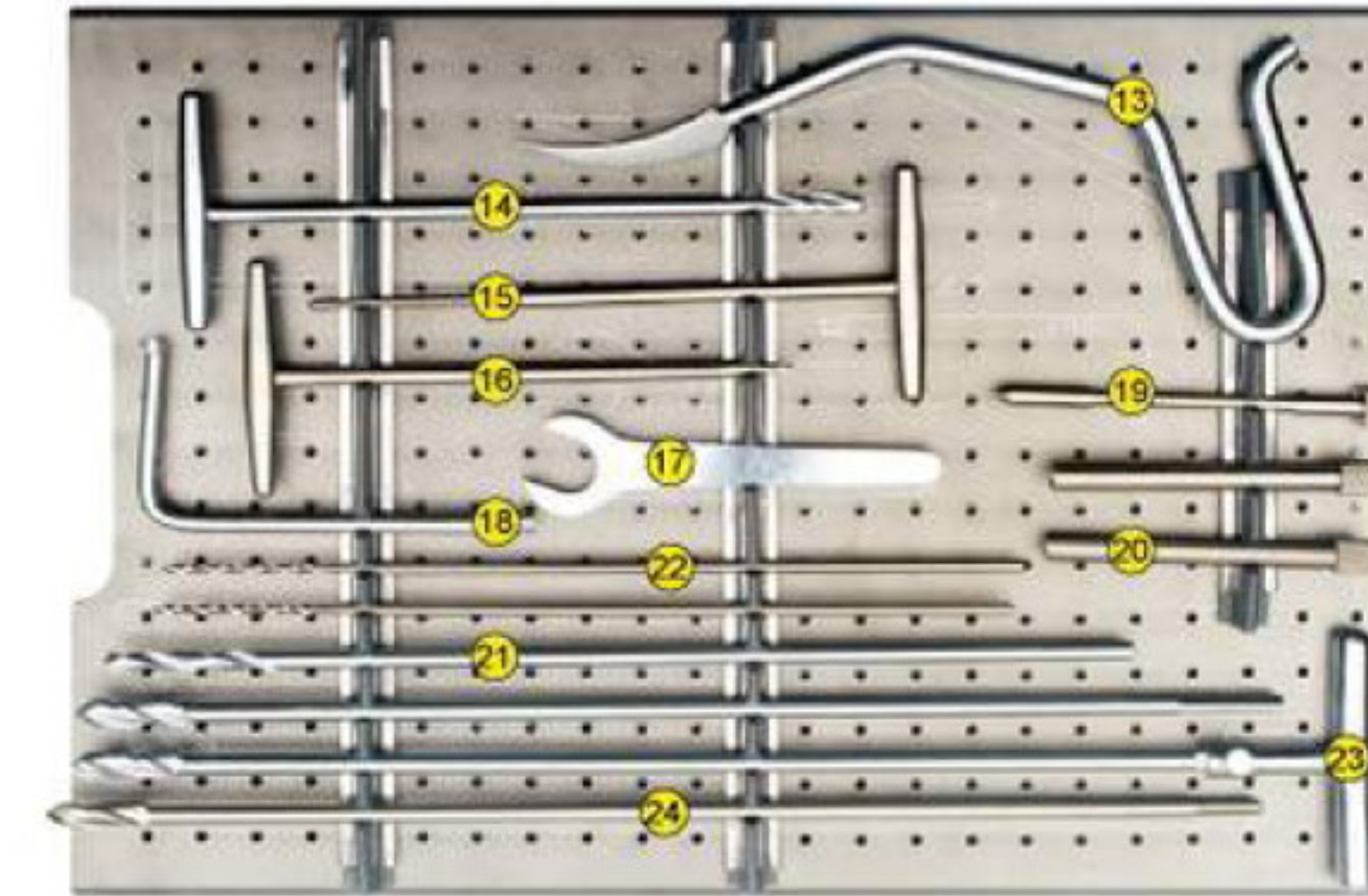

T3710
Self-locking Humeral Nail Instrument Case

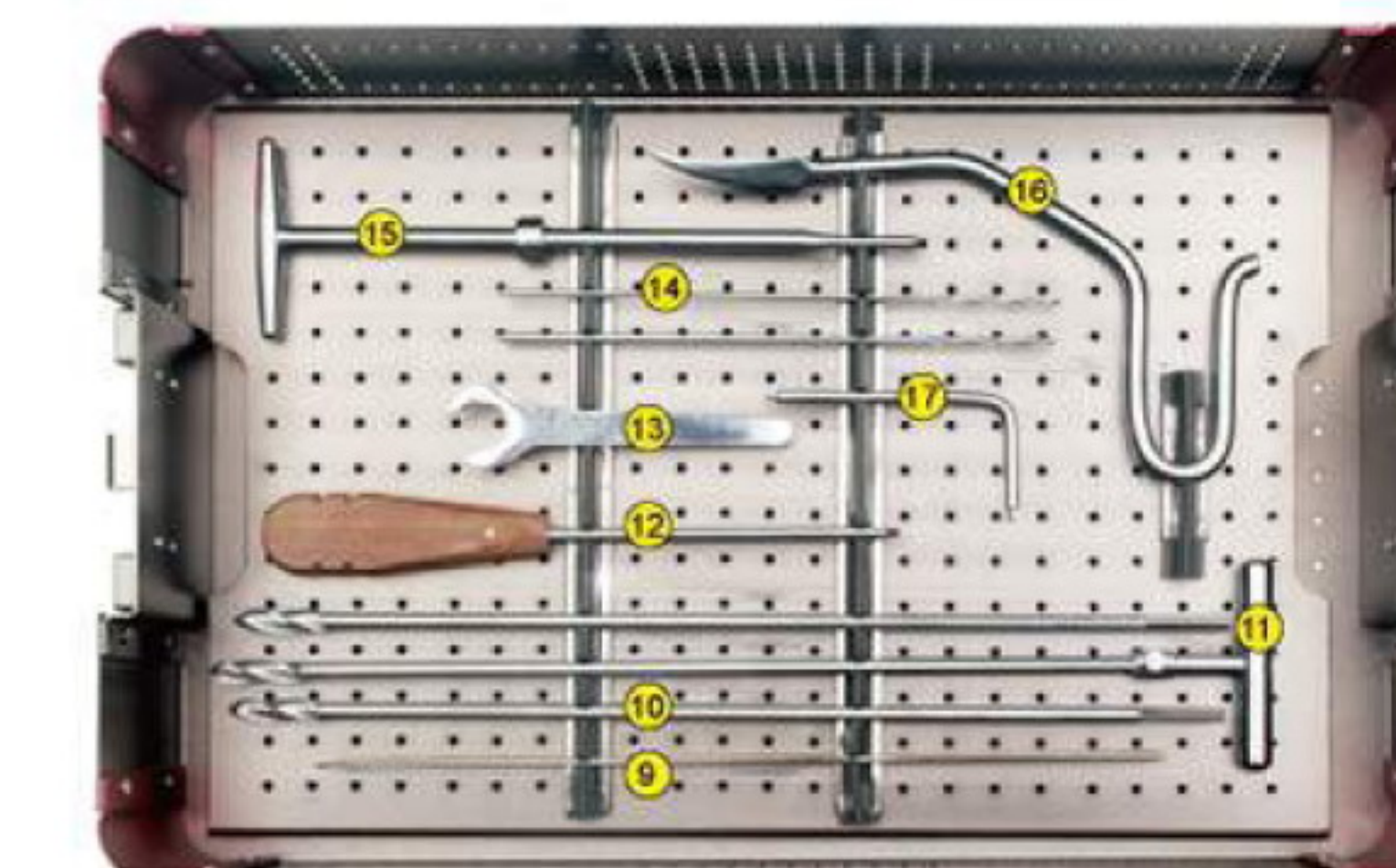
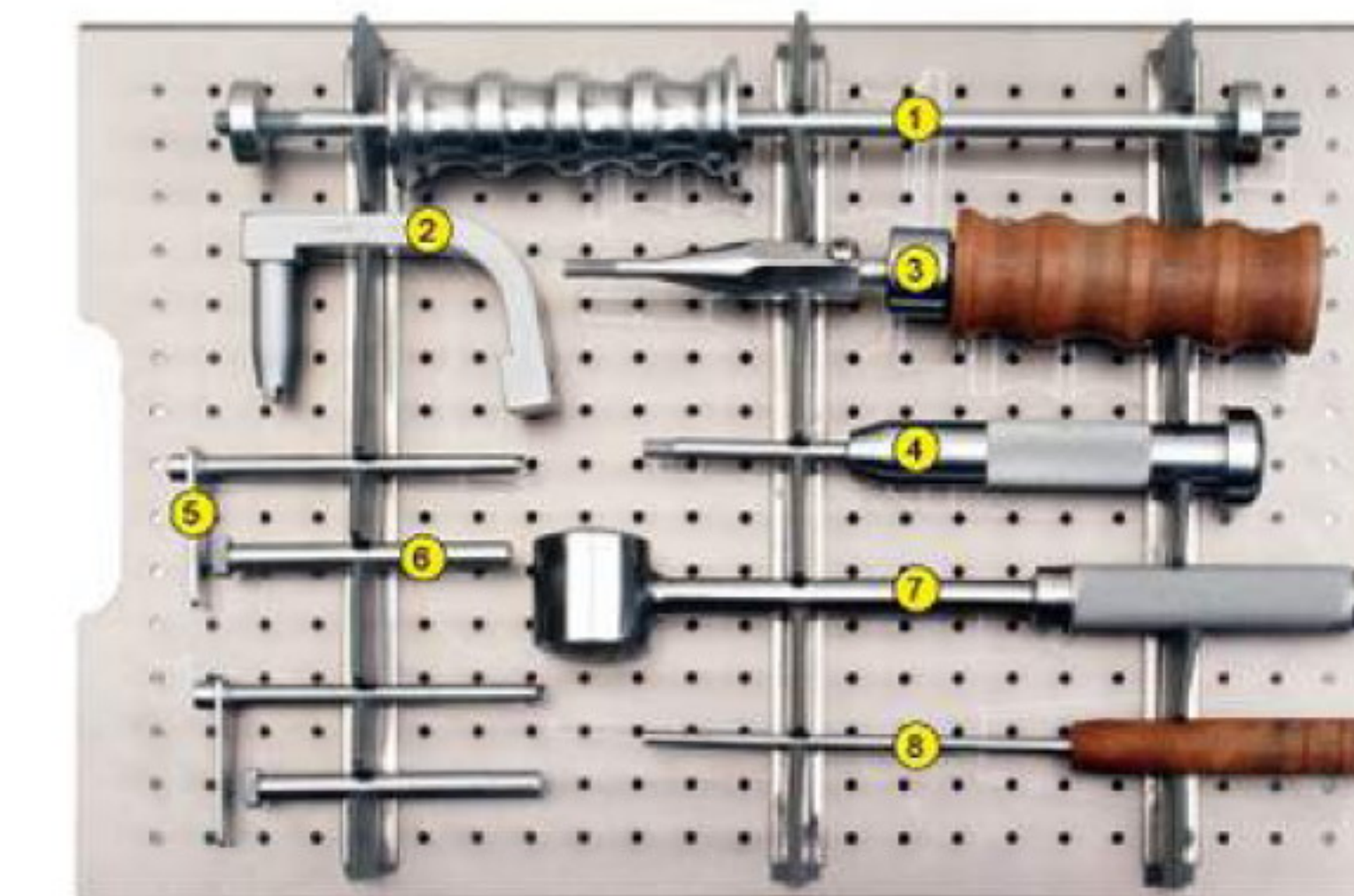

Product No.	Product Name	
T3610-0100		Target Device, Proximal
T3610-0200		Locking Connect Bolt
T3610-0300		U-Plate
T3610-0400		Proximal Drill Guide Device
T3610-0500		Distal Drill Guide Device
T3610-0600		Universal Adapter
T3610-0700		Drill Bit(with depth gauge)
T3610-0800		T-Screw Driver (Hex)SW3.5
T3610-0900		Target Drill Sleeve
T3610-1000		T-Locating Rod
T3610-1100		Guide Bar
T3610-1200		Insertor/Extractor Hammer
T3610-1300		Curved Awl
T3610-1400	5.5	T-Drill Bit
T3610-1500	HA3.5	Drill Sleeve
T3610-1600		T-Screw Driver (Hex)SW2.5
T3610-1700		16mm Wrench
T3610-1800		L-Screw Driver SW5
T3610-1900		Obturator
T3610-2000		Sieve
T3610-2100	Φ5	Bone Drill
T3610-2200	Φ2.9/Φ3.5	Combination Drill
T3610-2300		Reamer Handle
T3610-2400	Φ7.5	Reamer Φ7.5
T3610-2401	Φ8	Reamer Φ8
T3610-2402	Φ8.5	Reamer Φ8.5
T3610-2500		Guide Wire

Product No.	Product Name	
T3710-0100		Insertor/Extractor
T3710-0200		Target Device Handle Proximal
T3710-0300		Universal Adapter
T3710-0400		Target Device Connecting Bolt
T3710-0500		Drill Sleeve
T3710-0600		Sleeve
T3710-0700		Hammer
T3710-0800		Inner Part Insertor/Extractor
T3710-0900		Guide Pin
T3710-1000	Φ7	Reamer Φ7
T3710-1001	Φ8	Reamer Φ8
T3710-1002		Reamer Φ8.5
T3710-1100		Reamer Handle
T3710-1200		Screw Driver SW2.5
T3710-1300	16mm	Wrench 16mm
T3710-1400		Drill Bit Φ2.6
T3710-1401	Φ3.2	Drill Bit Φ3.2
T3710-1500		T-Screw Driver
T3710-1600		Awl
T3710-1700		L-Wrench
T3710-1800		Guide Wire

3110 | Solid Tibial Interlocking Nails (DJG- I)



Solid Tibial Interlocking Nails (DJG- I)

3111-2/5024-3115-2/5034

Product No.		Diameter of Nails	Length
Titanium Alloy	Stainless Steel		
3111-2024	3111-5024	8	240
3111-2026	3111-5026		260
3111-2028	3111-5028		280
3111-2030	3111-5030		300
3111-2032	3111-5032		320
3111-2034	3111-5034		340
3112-2024	3112-5024	9	240
3112-2026	3112-5026		260
3112-2028	3112-5028		280
3112-2030	3112-5030		300
3112-2032	3112-5032		320
3112-2034	3112-5034		340
3113-2024	3113-5024	10	240
3113-2026	3113-5026		260
3113-2028	3113-5028		280
3113-2030	3113-5030		300
3113-2032	3113-5032		320
3113-2034	3113-5034		340
3114-2024	3114-5024	11	240
3114-2026	3114-5026		260
3114-2028	3114-5028		280
3114-2030	3114-5030		300
3114-2032	3114-5032		320
3114-2034	3114-5034		340
3115-2028	3115-5028	12	280
3115-2030	3115-5030		300
3115-2032	3115-5032		320
3115-2034	3115-5034		340

3130 | Cannulated Tibial Interlocking Nails (DJG- II)



Cannulated Tibial Interlocking Nails (DJG- II)

3131-2/5024-3135-2/5034

Product No.		Diameter of Nails	Length	
Titanium Alloy	Stainless Steel			
3131-2024	3131-5024	8	240	
3131-2026	3131-5026		260	
3131-2028	3131-5028		280	
3131-2030	3131-5030		300	
3131-2032	3131-5032		320	
3131-2034	3131-5034		340	
3131-2036	3131-5036	9	360	
3131-2038	3131-5038		380	
3132-2024	3132-5024		9	240
3132-2026	3132-5026			260
3132-2028	3132-5028			280
3132-2030	3132-5030			300
3132-2032	3132-5032	320		
3132-2034	3132-5034	340		
3132-2036	3132-5036	10	360	
3132-2038	3132-5038		380	
3133-2024	3133-5024		10	240
3133-2026	3133-5026			260
3133-2028	3133-5028			280
3133-2030	3133-5030			300
3133-2032	3133-5032	320		
3133-2034	3133-5034	340		
3133-2036	3133-5036	11	360	
3133-2038	3133-5038		380	
3134-2028	3134-5028		11	280
3134-2030	3134-5030			300
3134-2032	3134-5032			320
3134-2034	3134-5034			340
3134-2036	3134-5036	12		360
3134-2038	3134-5038			380
3135-2028	3135-5028		12	280
3135-2030	3135-5030			300
3135-2032	3135-5032			320
3135-2034	3135-5034			340
3135-2036	3135-5036	360		
3135-2038	3135-5038	380		

3120 | Locking Screws

3120-2/5020-3120-2/5075



Product No.		Diameter of Screw	Length
Titanium Alloy	Stainless Steel		
3120-2020	3120-5020	4.2	20
3120-2025	3120-5025		25
3120-2030	3120-5030		30
3120-2035	3120-5035		35
3120-2040	3120-5040		40
3120-2045	3120-5045		45
3120-2050	3120-5050		50
3120-2055	3120-5055		55
3120-2060	3120-5060		60
3120-2065	3120-5065		65
3120-2070	3120-5070		70
3120-2075	3120-5075		75

3121 | Locking Screws (Full Threaded)

3121-2/5025-3121-2/5070



Product No.		Diameter of Screw	Length
Titanium Alloy	Stainless Steel		
3121-2025	3121-5025	4.2	25
3121-2030	3121-5030		30
3121-2035	3121-5035		35
3121-2040	3121-5040		40
3121-2045	3121-5045		45
3121-2050	3121-5050		50
3121-2055	3121-5055		55
3121-2060	3121-5060		60
3121-2065	3121-5065		65
3121-2070	3121-5070		70

3140 | Tibial Interlocking Nails(New Type)



Note:3146 locking screw only use for proximal part,3145 locking screw use for other parts.

Tibial Interlocking Nails(New Type)

3140-2/5255~3142-2/5375



Product No.		Diameter of Nails	Length
Titanium Alloy	Stainless Steel		
3140-2255	3140-5255	8.5	255
3140-2270	3140-5270		270
3140-2285	3140-5285		285
3140-2300	3140-5300		300
3140-2315	3140-5315		315
3140-2330	3140-5330		330
3140-2345	3140-5345	345	
3140-2360	3140-5360	360	
3141-2255	3141-5255	9	255
3141-2270	3141-5270		270
3141-2285	3141-5285		285
3141-2300	3141-5300		300
3141-2315	3141-5315		315
3141-2330	3141-5330		330
3141-2345	3141-5345	345	
3141-2360	3141-5360	360	
3142-2255	3142-5255	10	255
3142-2270	3142-5270		270
3142-2285	3142-5285		285
3142-2300	3142-5300		300
3142-2315	3142-5315		315
3142-2330	3142-5330		330
3142-2345	3142-5345	345	
3142-2360	3142-5360	360	

3146 | Locking Screws 4.8 (Cortex & Cancellous Threaded)

3146-2/5025~3146-2/5090



Product No.		Diameter of Screw	Length
Titanium Alloy	Stainless Steel		
3146-2025	3146-5025	4.8	25
3146-2030	3146-5030		30
3146-2035	3146-5035		35
3146-2040	3146-5040		40
3146-2045	3146-5045		45
3146-2050	3146-5050		50
3146-2055	3146-5055		55
3146-2060	3146-5060		60
3146-2065	3146-5065		65
3146-2070	3146-5070		70
3146-2075	3146-5075		75
3146-2080	3146-5080		80
3146-2085	3146-5085		85
3146-2090	3146-5090		90

3147 | Tibial End-cap

3147-2/5000~3147-2/5100



Product No.		Specifications
Titanium Alloy	Stainless Steel	
3147-2000	3147-5000	0
3147-2005	3147-5005	5
3147-2010	3147-5010	10
3147-2015	3147-5015	15
3147-2100	3147-5100	0

3145 | Locking Screws 4.3

3145-2/5024~3145-2/5088



Product No.		Diameter of Screw	Length
Titanium Alloy	Stainless Steel		
3145-2025	3145-5025	4.3	25
3145-2030	3145-5030		30
3145-2035	3145-5035		35
3145-2040	3145-5040		40
3145-2045	3145-5045		45
3145-2050	3145-5050		50
3145-2055	3145-5055		55
3145-2060	3145-5060		60
3145-2065	3145-5065		65
3145-2070	3145-5070		70
3145-2075	3145-5075		75
3145-2080	3145-5080		80
3145-2085	3145-5085		85
3145-2090	3145-5090		90

INTERLOCKING NAIL SERIES

INTERLOCKING NAIL SERIES

Femoral Interlocking Nails(New Type)



Product No.		Diameter of Nails	Length
Titanium Alloy	Stainless Steel		
3480-2180	3480-5180	9	180
3480-2200	3480-5200		200
3480-2220	3480-5220		220
3480-2240	3480-5240		240
3481-2180	3481-5180	10	180
3481-2200	3481-5200		200
3481-2220	3481-5220		220
3481-2240	3481-5240		240
3482-2180	3482-5180	11	180
3482-2200	3482-5200		200
3482-2220	3482-5220		220
3482-2240	3482-5240		240

J2 3486 | Locking Screws

3486-2/5065~3486-2/5105



Product No.		Diameter of Screw	Length
Titanium Alloy	Stainless Steel		
3486-2065	3486-5065	6.4	65
3486-2070	3486-5070		70
3486-2075	3486-5075		75
3486-2080	3486-5080		80
3486-2085	3486-5085		85
3486-2090	3486-5090		90
3486-2095	3486-5095		95
3486-2100	3486-5100		100
3486-2105	3486-5105		105

Femoral Interlocking Nails(New Type)

3480-2/5180~3482-2/5240



Product No.		Diameter of Nails	Length
Titanium Alloy	Stainless Steel		
3490-2132	3490-5132	9	320 L
3490-2232	3490-5232		320 R
3490-2134	3490-5134		340 L
3490-2234	3490-5234		340 R
3490-2136	3490-5136		360 L
3490-2236	3490-5236		360 R
3490-2138	3490-5138		380 L
3490-2238	3490-5238		380 R
3490-2140	3490-5140		400 L
3490-2240	3490-5240		400 R
3490-2142	3490-5142		420 L
3490-2242	3490-5242		420 R
3490-2144	3490-5144	10	440 L
3490-2244	3490-5244		440 R
3491-2132	3491-5132		320 L
3491-2232	3491-5232		320 R
3491-2134	3491-5134		340 L
3491-2234	3491-5234		340右 R
3491-2136	3491-5136		360 L
3491-2236	3491-5236		360右 R
3491-2138	3491-5138		380 L
3491-2238	3491-5238		380右 R
3491-2140	3491-5140		400 L
3491-2240	3491-5240		400右 R
3491-2142	3491-5142	420 L	
3491-2242	3491-5242	420右 R	
3491-2144	3491-5144	440 L	
3491-2244	3491-5244	440右 R	
3492-2132	3492-5132	11	320 L
3492-2232	3492-5232		320右 R
3492-2134	3492-5134		340 L
3492-2234	3492-5234		340右 R
3492-2136	3492-5136		360 L
3492-2236	3492-5236		360右 R
3492-2138	3492-5138		380 L
3492-2238	3492-5238		380右 R
3492-2140	3492-5140		400 L
3492-2240	3492-5240		400右 R
3492-2142	3492-5142		420 L
3492-2242	3492-5242		420右 R
3492-2144	3492-5144	440 L	
3492-2244	3492-5244	440右 R	

J4 3487 | Locking Screws

3487-2/5026~3487-2/5084



Product No.		Diameter of Screw	Length
Titanium Alloy	Stainless Steel		
3487-2026	3487-5026	4.8	26
3487-2028	3487-5028		28
3487-2030	3487-5030		30
3487-2032	3487-5032		32
3487-2034	3487-5034		34
3487-2036	3487-5036		36
3487-2038	3487-5038		38
3487-2040	3487-5040		40
3487-2042	3487-5042		42
3487-2044	3487-5044		44
3487-2046	3487-5046		46
3487-2048	3487-5048		48
3487-2050	3487-5050		50
3487-2052	3487-5052		52
3487-2054	3487-5054		54
3487-2056	3487-5056		56
3487-2058	3487-5058		58
3487-2060	3487-5060		60
3487-2064	3487-5064		64
3487-2068	3487-5068		68
3487-2072	3487-5072	72	
3487-2076	3487-5076	76	
3487-2080	3487-5080	80	
3487-2084	3487-5084	84	

Femoral Interlocking Nails(New Type)

3490-2/5132~3492-2/5244



3485 | Femur End-cap

3485-2/5000~3485-2/5015



Product No.		Specifications
Titanium Alloy	Stainless Steel	
3485-2000	3485-5000	0
3485-2005	3485-5005	5
3485-2010	3485-5010	10
3485-2015	3485-5015	15

INTERLOCKING NAIL SERIES

(DGG- I) 3210 | Femoral Interlocking Nails



(DGG- I) | Femoral Interlocking Nails

3211-2/5032~3215-2/5044



(DGG- II) 3310 | Femoral Interlocking Nails



(DGG- II) Femoral Interlocking Nails

3311-2/5018~3314-2/5034



Product No.		Diameter of Nails	Length	
Titanium Alloy	Stainless Steel			
3211-2032	3211-5032	9	320	
3211-2034	3211-5034		340	
3211-2036	3211-5036		360	
3211-2038	3211-5038		380	
3211-2040	3211-5040		400	
3211-2042	3211-5042		420	
3211-2044	3211-5044		440	
3212-2032	3212-5032		10	320
3212-2034	3212-5034	340		
3212-2036	3212-5036	360		
3212-2038	3212-5038	380		
3212-2040	3212-5040	400		
3212-2042	3212-5042	420		
3212-2044	3212-5044	440		
3213-2034	3213-5034	11		340
3213-2036	3213-5036		360	
3213-2038	3213-5038		380	
3213-2040	3213-5040		400	
3213-2042	3213-5042		420	
3213-2044	3213-5044		440	
3214-2034	3214-5034		12	340
3214-2036	3214-5036			360
3214-2038	3214-5038	380		
3214-2040	3214-5040	400		
3214-2042	3214-5042	420		
3214-2044	3214-5044	440		
3215-2034	3215-5034	13		340
3215-2036	3215-5036			360
3215-2038	3215-5038		380	
3215-2040	3215-5040		400	
3215-2042	3215-5042		420	
3215-2044	3215-5044		440	

Product No.		Diameter of Nails	Length
Titanium Alloy	Stainless Steel		
3311-2018	3311-5018	9	180
3311-2020	3311-5020		200
3311-2022	3311-5022		220
3311-2024	3311-5024		240
3311-2026	3311-5026		260
3311-2028	3311-5028		280
3311-2030	3311-5030		300
3311-2032	3311-5032		320
3311-2034	3311-5034	10	340
3312-2018	3312-5018		180
3312-2020	3312-5020		200
3312-2022	3312-5022		220
3312-2024	3312-5024		240
3312-2026	3312-5026		260
3312-2028	3312-5028		280
3312-2030	3312-5030		300
3312-2032	3312-5032	11	320
3312-2034	3312-5034		340
3313-2018	3313-5018		180
3313-2020	3313-5020		200
3313-2022	3313-5022		220
3313-2024	3313-5024		240
3313-2026	3313-5026		260
3313-2028	3313-5028		280
3313-2030	3313-5030	12	300
3313-2032	3313-5032		320
3313-2034	3313-5034		340
3314-2018	3314-5018		180
3314-2020	3314-5020		200
3314-2022	3314-5022		220
3314-2024	3314-5024		240
3314-2026	3314-5026		260
3314-2028	3314-5028	280	
3314-2030	3314-5030	300	
3314-2032	3314-5032	320	
3314-2034	3314-5034	340	

INTERLOCKING NAIL SERIES

(DGM- I) 3410 | GAMMA Interlocking Nails - I

3411-2/5018~3414-2/5028



(DGM- I) | GAMMA Interlocking Nails - I

3411-2/5018~3414-2/5028



3220 | Locking Screw

3220-2/5020~3220-2/5090



3430 | Lag Screw

3430-2/5065~3430-2/5110



3230 | Locking Scerw(Full Threaded)

3230-2/5030~3230-2/5090



3450 | Locking Scerw(Half Threaded)

3450-2/5050~3450-2/5090



Product No.		Diameter of Nails	Length	
Titanium Alloy	Stainless Steel			
3411-2018	3411-5018	9	180	
3411-2020	3411-5020		200	
3411-2022	3411-5022		220	
3411-2024	3411-5024		240	
3411-2026	3411-5026		260	
3411-2028	3411-5028		280	
3412-2018	3412-5018		10	180
3412-2020	3412-5020			200
3412-2022	3412-5022	220		
3412-2024	3412-5024	240		
3412-2026	3412-5026	260		
3412-2028	3412-5028	280		
3413-2018	3413-5018	11		180
3413-2020	3413-5020			200
3413-2022	3413-5022		220	
3413-2024	3413-5024		240	
3413-2026	3413-5026		260	
3413-2028	3413-5028		280	
3414-2018	3414-5018		12	180
3414-2020	3414-5020			200
3414-2022	3414-5022	220		
3414-2024	3414-5024	240		
3414-2026	3414-5026	260		
3414-2028	3414-5028	280		

Product No.		Diameter of Nails	Length
Titanium Alloy	Stainless Steel		
3220-2020	3220-5020	4.7	20
3220-2025	3220-5025		25
3220-2030	3220-5030		30
3220-2035	3220-5035		35
3220-2040	3220-5040		40
3220-2045	3220-5045		45
3220-2050	3220-5050		50
3220-2055	3220-5055		55
3220-2060	3220-5060		60
3220-2065	3220-5065		65
3220-2070	3220-5070		70
3220-2075	3220-5075		75
3220-2080	3220-5080		80
3220-2085	3220-5085		85
3220-2090	3220-5090		90
3230-2030	3230-5030		30
3230-2035	3230-5035		35
3230-2040	3230-5040		40
3230-2045	3230-5045		45
3230-2050	3230-5050		50
3230-2055	3230-5055	55	
3230-2060	3230-5060	60	
3230-2065	3230-5065	65	
3230-2070	3230-5070	70	
3230-2075	3230-5075	75	
3230-2080	3230-5080	80	
3230-2085	3230-5085	85	
3230-2090	3230-5090	90	
3450-2050	3450-5050	50	
3450-2055	3450-5055	55	
3450-2060	3450-5060	60	
3450-2065	3450-5065	65	
3450-2070	3450-5070	70	
3450-2075	3450-5075	75	
3450-2080	3450-5080	80	
3450-2085	3450-5085	85	
3450-2090	3450-5090	90	

Product No.		Diameter of Screw	Length
Titanium Alloy	Stainless Steel		
3430-2065	3430-5065	6.5	65
3430-2070	3430-5070		70
3430-2075	3430-5075		75
3430-2080	3430-5080		80
3430-2085	3430-5085		85
3430-2090	3430-5090		90
3430-2095	3430-5095		95
3430-2100	3430-5100		100
3430-2105	3430-5105		105
3430-2110	3430-5110		110

INTERLOCKING NAIL SERIES

INTERLOCKING NAIL SERIES

(DGM-1) PFNA 3465 | PFNA Interlocking Nails – I



Product No.		Diameter of Nails	Length
Titanium Alloy	Stainless Steel		
3465-2018	3465-5018	11	180
3465-2020	3465-5020		200
3465-2022	3465-5022		220
3465-2024	3465-5024		240
3465-2118	3465-5118	12	180
3465-2120	3465-5120		200
3465-2122	3465-5122		220
3465-2124	3465-5124		240
3465-2218	3465-5218	9	180
3465-2220	3465-5220		200
3465-2222	3465-5222		220
3465-2224	3465-5224		240
3465-2318	3465-5318	10	180
3465-2320	3465-5320		200
3465-2322	3465-5322		220
3465-2324	3465-5324		240

(DGM-1) PFNA 3465 | GAMMA Interlocking Nails – I

3465-2/5018-3465-2/5324



3466 | Locking Scerw(Full Threaded)

3466-2/5026-3466-2/5100



Product No.		Diameter of Screw	Length
Titanium Alloy	Stainless Steel		
3466-2026	3466-5026	4.8	26
3466-2028	3466-5028		28
3466-2030	3466-5030		30
3466-2032	3466-5032		32
3466-2034	3466-5034		34
3466-2036	3466-5036		36
3466-2038	3466-5038		38
3466-2040	3466-5040		40
3466-2042	3466-5042		42
3466-2044	3466-5044		44
3466-2046	3466-5046		46
3466-2048	3466-5048		48
3466-2050	3466-5050		50
3466-2052	3466-5052		52
3466-2054	3466-5054		54
3466-2056	3466-5056		56
3466-2058	3466-5058		58
3466-2060	3466-5060		60
3466-2064	3466-5064		64
3466-2068	3466-5068		68
3466-2072	3466-5072	72	
3466-2076	3466-5076	76	
3466-2080	3466-5080	80	
3466-2085	3466-5085	85	
3466-2090	3466-5090	90	
3466-2095	3466-5095	95	
3466-2100	3466-5100	100	

3468 | End Cap

3468-2/5000-3468-2/5015



Product No.		Specifications
Titanium Alloy	Stainless Steel	
3468-2000	3468-5000	0
3468-2005	3468-5005	5
3468-2010	3468-5010	10
3468-2015	3468-5015	15

(DGM-1) PFNA 3470
GAMMA Interlocking Nails – I



(DGM-1) PFNA 3470
GAMMA Interlocking Nails – I

3470-2/5132-3473-2/5242



J6 3467 | Lag Screw

3467-2/5070-3467-2/5120



Product No.		Diameter of Nails	Length
Titanium Alloy	Stainless Steel		
3470-2132	3470-5132	9	320 L
3470-2232	3470-5232		320 R
3470-2134	3470-5134		340 L
3470-2234	3470-5234		340 R
3470-2136	3470-5136		360 L
3470-2236	3470-5236		360 R
3470-2138	3470-5138		380 L
3470-2238	3470-5238		380 R
3470-2140	3470-5140		400 L
3470-2240	3470-5240		400 R
3470-2142	3470-5142		420 L
3470-2242	3470-5242		420 R
3471-2132	3471-5132	10	320 L
3471-2232	3471-5232		320 R
3471-2134	3471-5134		340 L
3471-2234	3471-5234		340 R
3471-2136	3471-5136		360 L
3471-2236	3471-5236		360 R
3471-2138	3471-5138		380 L
3471-2238	3471-5238		380 R
3471-2140	3471-5140		400 L
3471-2240	3471-5240		400 R
3471-2142	3471-5142		420 L
3471-2242	3471-5242		420 R
3472-2132	3472-5132	11	320 L
3472-2232	3472-5232		320 R
3472-2134	3472-5134		340 L
3472-2234	3472-5234		340 R
3472-2136	3472-5136		360 L
3472-2236	3472-5236		360 R
3472-2138	3472-5138		380 L
3472-2238	3472-5238		380 R
3472-2140	3472-5140		400 L
3472-2240	3472-5240		400 R
3472-2142	3472-5142		420 L
3472-2242	3472-5242		420 R
3473-2132	3473-5132	12	320 L
3473-2232	3473-5232		320 R
3473-2134	3473-5134		340 L
3473-2234	3473-5234		340 R
3473-2136	3473-5136		360 L
3473-2236	3473-5236		360 R
3473-2138	3473-5138		380 L
3473-2238	3473-5238		380 R
3473-2140	3473-5140		400 L
3473-2240	3473-5240		400 R
3473-2142	3473-5142		420 L
3473-2242	3473-5242		420 R

Product No.		Diameter of Screw	Length
Titanium Alloy	Stainless Steel		
3467-2070	3467-5070	10.8	70
3467-2075	3467-5075		75
3467-2080	3467-5080		80
3467-2085	3467-5085		85
3467-2090	3467-5090		90
3467-2095	3467-5095		95
3467-2100	3467-5100		100
3467-2105	3467-5105		105
3467-2110	3467-5110		110
3467-2115	3467-5115		115
3467-2120	3467-5120		120

(DGM- II)

3510 | GAMMA Interlocking Nails – II

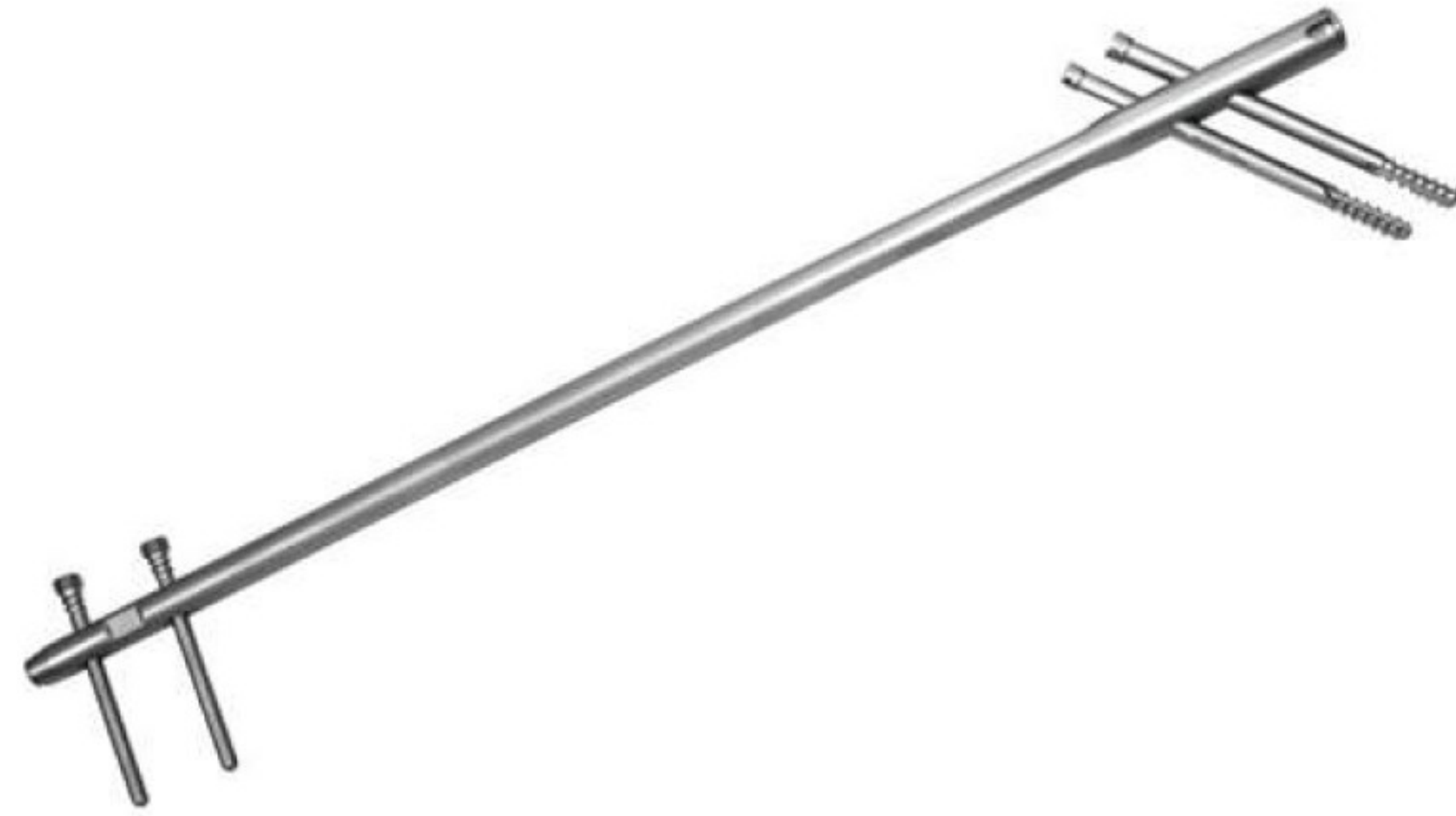

Product No.		Diameter of Nails	Length
Titanium Alloy	Stainless Steel		
3511-2132	3511-5132	9	320 L
3511-2232	3511-5232		320 R
3511-2134	3511-5134		340 L
3511-2234	3511-5234		340 R
3511-2136	3511-5136		360 L
3511-2236	3511-5236		360 R
3511-2138	3511-5138		380 L
3511-2238	3511-5238		380 R
3511-2140	3511-5140		400 L
3511-2240	3511-5240		400 R
3511-2142	3511-5142		420 L
3511-2242	3511-5242		420 R
3512-2132	3512-5132	10	320 L
3512-2232	3512-5232		320 R
3512-2134	3512-5134		340 L
3512-2234	3512-5234		340 R
3512-2136	3512-5136		360 L
3512-2236	3512-5236		360 R
3512-2138	3512-5138		380 L
3512-2238	3512-5238		380 R
3512-2140	3512-5140		400 L
3512-2240	3512-5240		400 R
3512-2142	3512-5142		420 L
3512-2242	3512-5242		420 R
3513-2132	3513-5132	11	320 L
3513-2232	3513-5232		320 R
3513-2134	3513-5134		340 L
3513-2234	3513-5234		340 R
3513-2136	3513-5136		360 L
3513-2236	3513-5236		360 R
3513-2138	3513-5138		380 L
3513-2238	3513-5238		380 R
3513-2140	3513-5140		400 L
3513-2240	3513-5240		400 R
3513-2142	3513-5142		420 L
3513-2242	3513-5242		420 R
3514-2132	3514-5132	12	320 L
3514-2232	3514-5232		320 R
3514-2134	3514-5134		340 L
3514-2234	3514-5234		340 R
3514-2136	3514-5136		360 L
3514-2236	3514-5236		360 R
3514-2138	3514-5138		380 L
3514-2238	3514-5238		380 R
3514-2140	3514-5140		400 L
3514-2240	3514-5240		400 R
3514-2142	3514-5142		420 L
3514-2242	3514-5242		420 R

(DGM- II)

GAMMA Interlocking Nails – II

3511-2/5132-3514-2/5242



3220 | Locking Scerw

3220-2/5020-3220-2/5090



3430 | Lag Screw

3430-2/5065-3430-2/5110



3230 | Locking Scerw (Full Threaded)

3230-2/5030-3230-2/5090



3450 | Locking Scerw (Half Threaded)

3450-2/5050-3450-2/5090



Product No.		Diameter of Screw	Length
Titanium Alloy	Stainless Steel		
3220-2020	3220-5020	4.7	20
3220-2025	3220-5025		25
3220-2030	3220-5030		30
3220-2035	3220-5035		35
3220-2040	3220-5040		40
3220-2045	3220-5045		45
3220-2050	3220-5050		50
3220-2055	3220-5055		55
3220-2060	3220-5060		60
3220-2065	3220-5065		65
3220-2070	3220-5070		70
3220-2075	3220-5075		75
3220-2080	3220-5080	80	
3220-2085	3220-5085	85	
3220-2090	3220-5090	90	
3230-2030	3230-5030	4.7	30
3230-2035	3230-5035		35
3230-2040	3230-5040		40
3230-2045	3230-5045		45
3230-2050	3230-5050		50
3230-2055	3230-5055		55
3230-2060	3230-5060		60
3230-2065	3230-5065		65
3230-2070	3230-5070		70
3230-2075	3230-5075		75
3230-2080	3230-5080		80
3230-2085	3230-5085		85
3230-2090	3230-5090	90	
3450-2050	3450-5050	6.5	50
3450-2055	3450-5055		55
3450-2060	3450-5060		60
3450-2065	3450-5065		65
3450-2070	3450-5070		70
3450-2075	3450-5075		75
3450-2080	3450-5080		80
3450-2085	3450-5085		85
3450-2090	3450-5090		90

Product No.		Diameter of Screw	Length
Titanium Alloy	Stainless Steel		
3430-2065	3430-5065	6.5	65
3430-2070	3430-5070		70
3430-2075	3430-5075		75
3430-2080	3430-5080		80
3430-2085	3430-5085		85
3430-2090	3430-5090		90
3430-2095	3430-5095		95
3430-2100	3430-5100		100
3430-2105	3430-5105		105
3430-2110	3430-5110		110

3461 | GAMMA Interlocking Nails (I)



Product No.		Diameter of Nails	Length
Titanium Alloy	Stainless Steel		
3461-2024	3461-5024	11	240
3461-2124	3461-5124	12	240
3461-2224	3461-5224	10	240

GAMMA Interlocking Nails (I)

3461-2/5024~3461-2/5124



Product No.		Diameter of Screw	Length
Titanium Alloy	Stainless Steel		
3462-2025	3462-5025	5	25
3462-2030	3462-5030		30
3462-2035	3462-5035		35
3462-2040	3462-5040		40
3462-2045	3462-5045		45
3462-2050	3462-5050		50
3462-2055	3462-5055		55
3462-2060	3462-5060		60
3462-2065	3462-5065		65
3462-2070	3462-5070		70

3462 | Locking Screw (Full Threaded)

3462-2/5025~3462-2/5070



Product No.		Diameter of Screw	Length
Titanium Alloy	Stainless Steel		
3463-2070	3463-5070	10.5	70
3463-2075	3463-5075		75
3463-2080	3463-5080		80
3463-2085	3463-5085		85
3463-2090	3463-5090		90
3463-2095	3463-5095		95
3463-2100	3463-5100		100
3463-2105	3463-5105		105
3463-2110	3463-5110		110
3463-2115	3463-5115		115
3463-2120	3463-5120		120

3463 | Lag Screw

3463-2/5070~3463-2/5120



3464 | End Cap

3464-2/5000~3464-2/5010



Product No.		Standard
Titanium Alloy	Stainless Steel	
3464-2000	3464-5000	0
3464-2005	3464-5005	5
3464-2010	3464-5010	10

3490 | Femoral Interlocking Nails Instrument Case

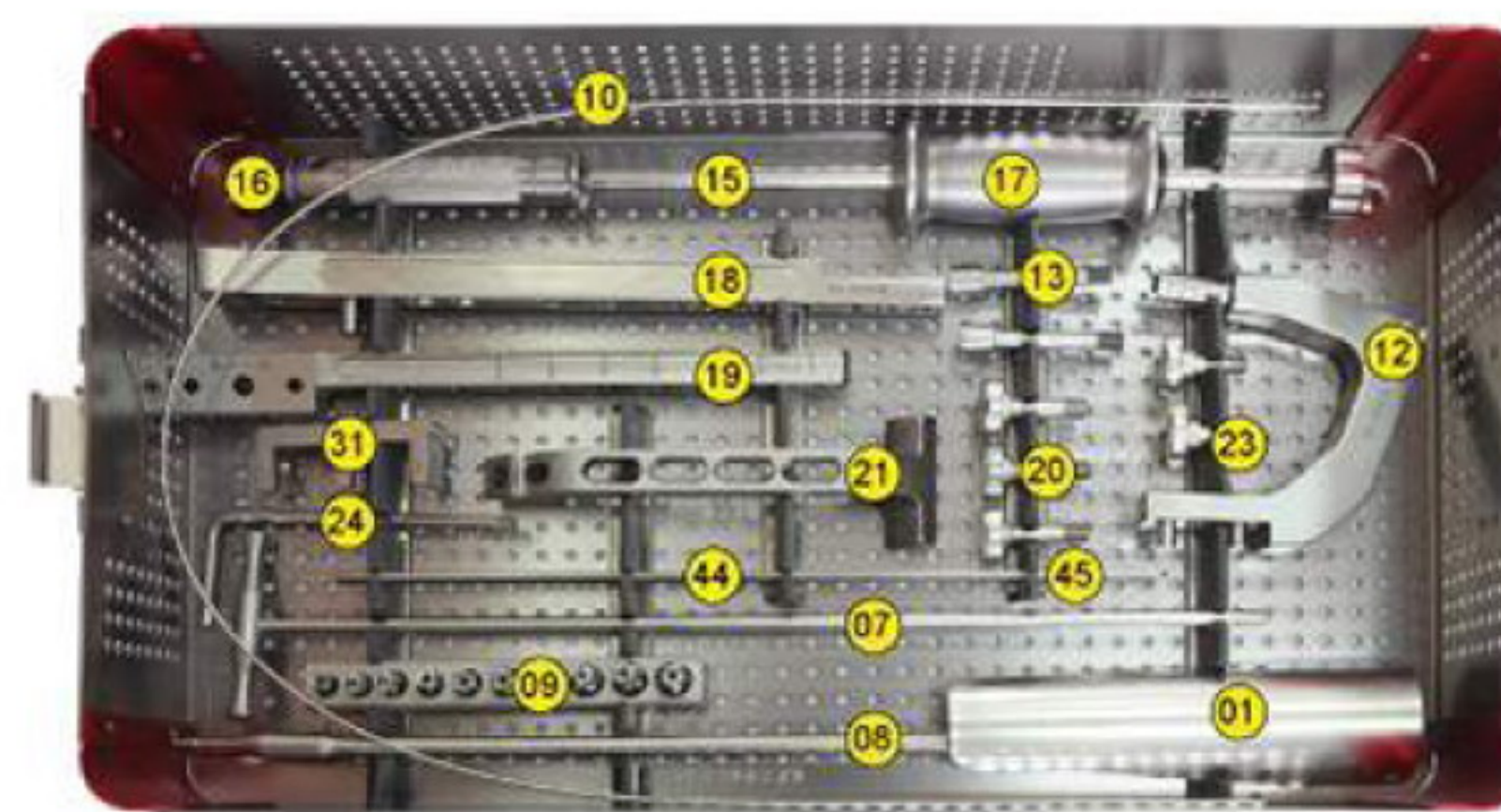
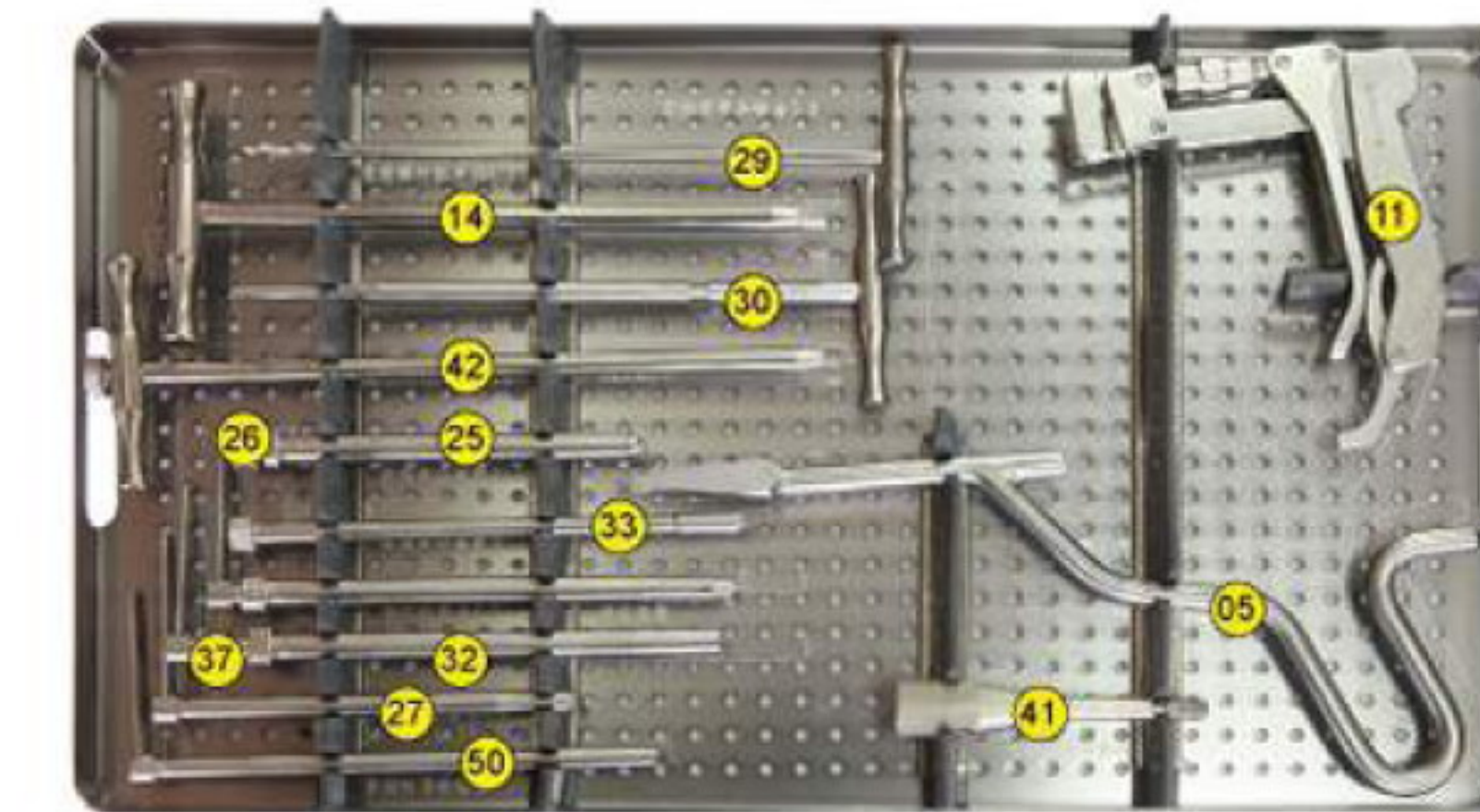
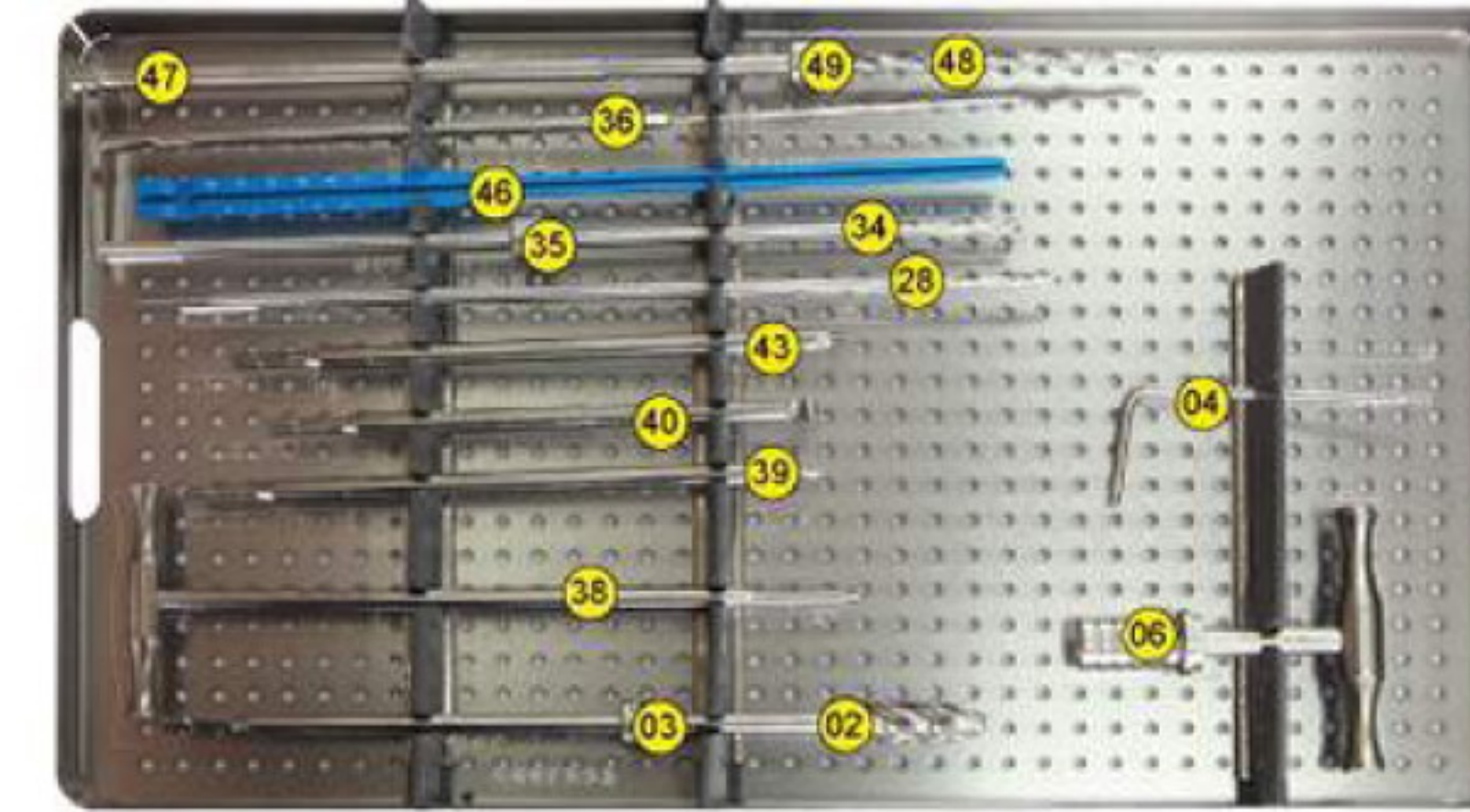

Product No.	Product Name	
T3490-0100		Tissue Protector
T3490-0200		Cannulated Reamer (Proximal)
T3490-0300		Reamer Stop
T3490-0400		Limitted Stop Wrench
T3490-0500		Open Awl
T3490-0600		Quick Coupling Handle
T3490-0700		Reduction Rod(Guide Wire Lutroducer)
T3490-0800	2.5/Φ8	Flexible Reamer Shaft Φ2.5/Φ8
T3490-0900	8.5-Φ13	Flexible Reamer Head Φ8.5-Φ13
T3490-1000	2.5/Φ4	Guide WireΦ2.5/Φ4 With Ball Head
T3490-1100	2.5	Guide Wire Holder Φ2.5
T3490-1200		Handle
T3490-1300		Threaded Rod Connecting
T3490-1400	6.5	Threaded Rod Connecting Wrench
T3490-1500		Sliding Hammer Rod
T3490-1600		Sliding Hammer Screw Nut
T3490-1700		Sliding Hammer
T3490-1800		Proximal Guide Bar
T3490-1900		Distal Guide Bar
T3490-2000		Locking Screw Connecting Rod
T3490-2100		Distal Locating Device
T3490-2300		Locking Screw
T3490-2400	SW5	Locking Screw Wrench SW5
T3490-2500		Locating Rod Sleeve
T3490-2600	8.1*120	Soft Tissue Separator
T3490-2700	Φ5.2	Locating Rod Φ5.2
T3490-2800	5.2	Locating Rod Φ5.2
T3490-2900	Φ5.2	Locating Rod Φ5.2
T3490-3000		Stabilizing Rod
T3490-3100		Locating Block
T3490-3200		Locking Hole Sleeve
T3490-3300	Φ8.1*155	Soft Tissue Separator
T3490-3400	4.3	Drill Bit for Locking Hole
T3490-3500	Φ4.3	Drill StopΦ4.3
T3490-3600		Locking Hole Depth Gauge
T3490-3700	Φ4.3	Drill Sleeve for Locking Screws Φ4.3
T3490-3800	3.5	T-Wrench for Locking Screws SW3.5
T3490-3900	3.5	Wrench for Locking Screws SW3.5
T3490-4000	6.5	Wrench For Connecting Threaded Rod SW6.5
T3490-4100		Main Nail Extractor
T3490-4200	3.5	Wrench For Femur Neck Locking Screws SW3.5M3.5
T3490-4300	5	Wrench For Femur Neck Locking Screws SW5.5
T3490-4400	2.5*320	Femur Neck Guide Wire Φ2.5*320
T3490-4500	Φ2.5*320	Femur Neck Guide Wire(thread)Φ2.5*320
T3490-4600	2.5*320	Femur Neck Depth Gauge
T3490-4700	Φ6.4	Femur Neck Drill Sleeve Φ6.4
T3490-4800	6.4	Combination Drill Bit Φ6.4
T3490-4900	Φ6.4	Stop For Combination Drill Bit Φ6.4
T3490-5000	2.5	Femur Neck Guide Wire Sleeve Φ2.5

FOREFOOT FRACTURE FIXATION SYSTEM

FOREFOOT FRACTURE FIXATION SYSTEM

6261 |
Forefoot osteotomy universal locking Plate



Product No.(Pure Titanium)	Size	Screws
6261-3003	3孔(Holes)*17mm	6532 HC2.0 4512 HA2.0 6533 HC2.4 4513 HA2.4

6261 |
Forefoot metatarsal Osteotomy Unibersal Locking plate



Product No.(Pure Titanium)	Size	Screws
6261-3004	4孔(Holes)*23mm	6532 HC2.0 4512 HA2.0 6533 HC2.4 4513 HA2.4

6141 |
Forefoot Straight Universal Locking Plate



Product No.(Pure Titanium)	Size	Screws
6141-3003	3孔(Holes)*23mm	6532 HC2.0 4512 HA2.0
6141-3004	4孔(Holes)*30mm	6533 HC2.4
6141-3006	6孔(Holes)*44mm	4513 HA2.4

6262 |
Forefoot T- Universal Locking Plate



Product No.(Pure Titanium)	Size	Screws
6262-3004	4孔(Holes)*34mm	6532 HC2.0 4512 HA2.0
6262-3005	5孔(Holes)*41mm	6533 HC2.4 4513 HA2.4

6263 |
Forefoot L- Universal Locking Plate



Product No.(Pure Titanium)	Size	Screws
6263-3004	6孔(Holes)*34mm	6532 HC2.0 4512 HA2.0 6533 HC2.4 4513 HA2.4

6532 |
Forefoot locking screws

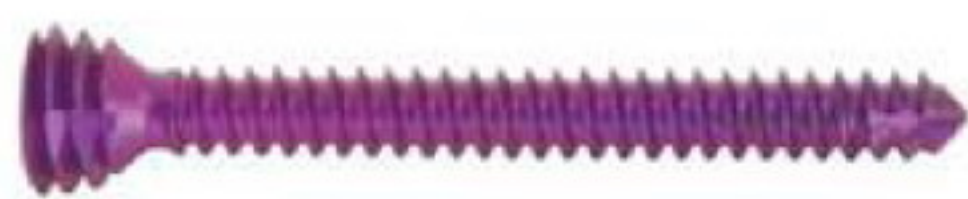

Product No.(Pure Titanium)	Size	Length
6532-2008	2.0	8
6532-2010		10
6532-2012		12
6532-2014		14
6532-2016		16
6532-2018		18
6532-2020		20
6532-2022		22
6532-2024		24
6532-2026		26
6532-2028		28
6532-2030		30

6533 |
Forefoot locking screws



Product No.(Pure Titanium)	Size	Length
6533-2008	2.4	8
6533-2010		10
6533-2012		12
6533-2014		14
6533-2016		16
6533-2018		18
6533-2020		20
6533-2022		22
6533-2024		24
6533-2026		26
6533-2028		28
6533-2030		30

4512 |
Forefoot screws



Product No.(Pure Titanium)	Size	Length
4512-2008	2.0	8
4512-2010		10
4512-2012		12
4512-2014		14
4512-2016		16
4512-2018		18
4512-2020		20
4512-2022		22
4512-2024		24
4512-2026		26
4512-2028		28
4512-2030		30

4513 |
Forefoot screws



Product No.(Pure Titanium)	Size	Length
4513-2008	2.0	8
4513-2010		10
4513-2012		12
4513-2014		14
4513-2016		16
4513-2018		18
4513-2020		20
4513-2022		22
4513-2024		24
4513-2026		26
4513-2028		28
4513-2030		30

FOREFOOT RECONSTRUCTION LOCKING PLATE SYSTEMS

FOREFOOT RECONSTRUCTION LOCKING PLATE SYSTEMS

6251 |

Forefoot Midfoot General Locking Plate



Product No.(Pure Titanium)	Size	Screws
6251-3000	4孔(Holes)*3mm	6535 HC2.7 6137 HA2.7
6251-3001	4孔(Holes)*4mm	
6251-3002	4孔(Holes)*5mm	
6251-3003	4孔(Holes)*6mm	
6251-3004	4孔(Holes)*6mm	
6251-3005	4孔(Holes)*7mm	

6253 |

Forefoot hallux valgus locking Plate



Product No.(Pure Titanium)	Size	Screws
6253-3001	4孔(Holes)*18mm	6535 HC2.7 6137 HA2.7
6253-3002	4孔(Holes)*20mm	
6253-3003	4孔(Holes)*22mm	
6253-3004	4孔(Holes)*24mm	

6264 |

Forefoot metatarsophalangeal Locking Plate



Product No.(Pure Titanium)	Size	Screws
6264-3001	4孔(Holes)*19.8mm	6535 HC2.7 6137 HA2.7
6264-3002	4孔(Holes)*26mm	
6264-3003	4孔(Holes)*33.4mm	

6535 |

Forefoot Locking screws



Product No.(Pure Titanium)	Size	Length
6535-2008	2.7	8
6535-2010		10
6535-2012		12
6535-2014		14
6535-2016		16
6535-2018		18
6535-2020		20
6535-2022		22
6535-2024		24
6535-2026		26
6535-2028		28
6535-2030		30

6317 |

Forefoot screws



Product No.(Pure Titanium)	Size	Length
6317-2008	2.7	8
6317-2010		10
6317-2012		12
6317-2014		14
6317-2016		16
6317-2018		18
6317-2020		20
6317-2022		22
6317-2024		24
6317-2026		26
6317-2028		28
6317-2030		30

6251 |

Forefoot and Rearfoot Fracture Instrument Set

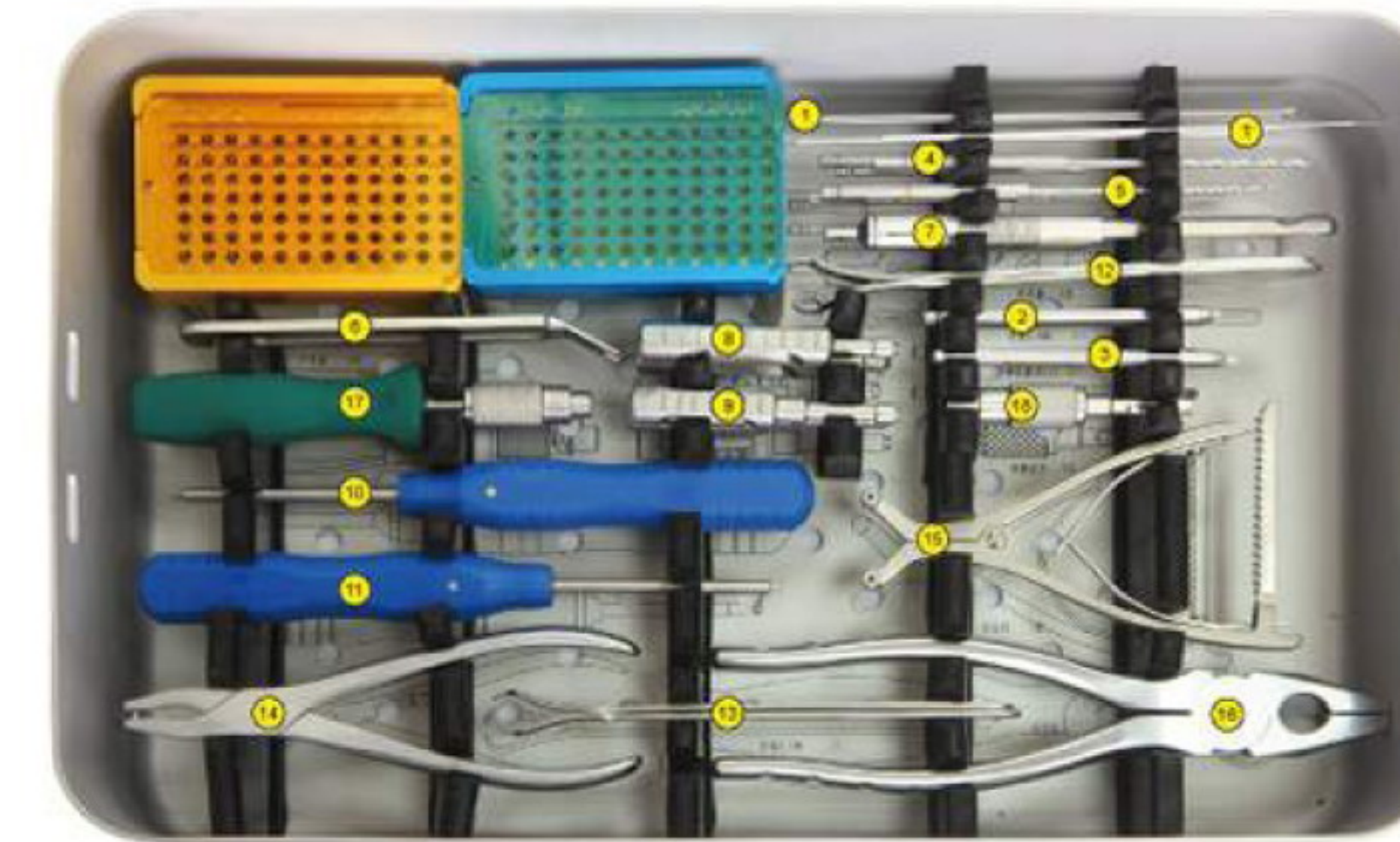

Product No.	Length
T6251-0100	
T6251-0101	
T6251-0200	2.5
T6251-0300	2.85
T6251-0400	2.0mm
T6251-0500	1.6mm
T6251-0600	
T6251-0700	
T6251-0800	2
T6251-0900	1.6
T6251-1000	2.5
T6251-1100	2.85
T6251-1200	6.5mm
T6251-1300	8.5mm
T6251-1400	
T6251-1500	
T6251-1600	
T4701-0700	
T4701-0800	

REAR-FOOT RECONSTRUCTION LOCKING PLATE SYSTEMS

REAR-FOOT RECONSTRUCTION LOCKING PLATE SYSTEMS

6259 |

Rearfoot tarsometatarsal joint fusion trapezoid shifting Locking Plate



Product No.(Pure Titanium)	Size	Screws
6259-3001	4孔(Holes)*20.6mm	6536 HC3.5 6138 HC3.5
6259-3002		
6259-3003		
6259-3004		
6259-3005		
6259-3006		

6258 |

Rearfoot calcaneus trapezoid shifting Locking Plate



Product No.(Pure Titanium)	Size	Screws
6258-3001	4孔(Holes)*12mm	6536 HC3.5 6138 HC3.5
6258-3002		
6258-3003		

6256 |

Rearfoot osteotomy Fusion Locking Plate



Product No.(Pure Titanium)	Size	Screws
6256-3001	4孔(Holes)*16mm	6536 HC3.5 6138 HC3.5
6256-3002	4孔(Holes)*18mm	
6256-3003	4孔(Holes)*20mm	
6256-3004	4孔(Holes)*22mm	

6255 |

Rearfoot calcaneus trapezoid shifting Locking Plate



Product No.(Pure Titanium)	Size	Screws
6255-3001	3孔(Holes)*53.5mm	6536 HC3.5 6138 HC3.5
6255-3002	3孔(Holes)*62.1mm	
6255-3003	4孔(Holes)*70.2mm	

6254 |

Rearfoot mesopodium General Locking Plate



Product No.(Pure Titanium)	Size	Screws
6254-3001	4孔(Holes)*12mm	6536 HC3.5 6138 HC3.5
6254-3002	4孔(Holes)*16mm	
6254-3003	4孔(Holes)*20mm	
6254-3004	4孔(Holes)*24mm	
6254-3005	4孔(Holes)*30mm	

6536 |

Rearfoot Locking Screws



Product No.(Pure Titanium)	Size	Length
6536-2014	3.5	14
6536-2016		16
6536-2018		18
6536-2020		20
6536-2022		22
6536-2024		24
6536-2026		26
6536-2028		28
6536-2030		30
6536-2035		35
6536-2040		40

6252 |

Rearfoot Lateral and Medial Reconstruction Locking Plate



Product No.(Pure Titanium)	Size	Screws
6252-3006	4孔(Holes)*34.5mm	6536 HC3.5 6138 HC3.5
6252-3008	4孔(Holes)*49mm	
6252-3014	4孔(Holes)*66.8mm	

4515 |

Rearfoot Screw



Product No.(Pure Titanium)	Size	Length
4515-2014	3.5	14
4515-2016		16
4515-2018		18
4515-2020		20
4515-2022		22
4515-2024		24
4515-2026		26
4515-2028		28
4515-2030		30
4515-2035		35
4515-2040		40

6257 |

Rearfoot tarsal Flat Locking Plate



Product No.(Pure Titanium)	Size	Screws
6257-3001	4孔(Holes)*34.5mm	6536 HC3.5 6138 HC3.5
6257-3002	4孔(Holes)*49mm	
6257-3003	4孔(Holes)*66.8mm	